

# **Payment service provider's report on cross-border payments (CESOP report)**

Technical instructions for application

## Table of contents

<b>1</b>	<b>CESOP TECHNICAL INSTRUCTIONS FOR APPLICATION</b>	<b>4</b>
1.1	Document reading instructions	4
<b>2</b>	<b>ILMOITIN.FI SERVICE</b>	<b>5</b>
2.1	Technical factors related to files	5
<b>3</b>	<b>FILE NAMES</b>	<b>6</b>
<b>4</b>	<b>SUBMITTING REPORTS</b>	<b>6</b>
<b>5</b>	<b>NIL REPORTING</b>	<b>7</b>
<b>6</b>	<b>CORRECTIONS</b>	<b>7</b>
<b>7</b>	<b>XML SCHEMA STRUCTURE</b>	<b>8</b>
<b>8</b>	<b>CESOP</b>	<b>9</b>
8.1	MessageSpec	9
8.2	PaymentDataBody	12
8.2.1	ReportingPSP	12
8.2.2	ReportedPayee	13
8.2.2.1	ReportedTransaction	17
8.2.3	Address elements	20
8.2.3.1	AddressFix	21
8.2.3.2	AddressFree	22
8.2.4	DocSpec element	22
8.3	ValidationResult	23
8.3.1	MessageSpec	23
8.3.2	ValidationResult	24
8.3.3	ValidationErrors	25
<b>9</b>	<b>CHECKS MADE BY ILMOITIN</b>	<b>27</b>
<b>10</b>	<b>NOTIFICATIONS FROM ILMOITIN</b>	<b>30</b>
<b>11</b>	<b>MORE INFORMATION AND LINKS</b>	<b>30</b>

**VERSION HISTORY**

<b>Version</b>	<b>Date</b>	<b>Content and notes</b>
1.1	29.4.2024	<p>Submitting the information about timestamp has been specified.</p> <p>Texts have been revised as follows.</p> <p>8.2.1 ReportingPSP</p> <p>8.2.2 ReportedPayee</p> <p>The texts regarding AccountIdentifier and Representative elements have been specified. The element specific namespace requirement has been removed.</p> <p>The check 30100 will be removed.</p>
1.0	6 March 2024	<p>The rules regarding special characters have been specified in Section 2.1 Tarkennettu kohdassa 2.1.erikoismerkkien säännöt.</p>
	28 December 2023	<p>AccountIdentifier has been specified: enter data, such as IBAN, without spaces.</p> <p>The text of section 6 — Corrections has been made more precise.</p>
	11 September 2023	
	18 August 2023	<p>The text of section 6 — Making corrections has been updated with more precise information.</p>
	8 August 2023	<p>The text and the check process relating to “Amount” was revised.</p> <p>Text on the use of UUID ver. 4 generator was added</p> <p>Updated text in section VATId</p> <p>First version</p>

# 1 CESOP technical instructions for application

The CESOP (Central Electronic System of Payment information) is a system administered by the European Commission in which payment data on cross-border payments reported by payment service providers (PSPs) is collected. The payment is considered a cross-border payment, if the payer is located in one member state and the payee in another member state, a third territory or a third country.

Finnish PSPs or PSPs providing payment services to payees in Finland should use this report to report the payment data information specified in section 29 of the act on assessment procedure for self-assessed taxes (Laki oma-aloitteisten verojen verotusmenettelystä 768/2016) to the Finnish Tax Administration. When payee's PSP is located in the European Union, it has the obligation to report the payment. If payee's PSP is located outside the European Union, then payer's PSP is obliged to report the payment.

The Finnish Tax Administration transmits the payment data reported by the PSP to the CESOP.

In addition, this report is used for nil reporting by PSPs that have no new payment data to report for a quarter.

The Finnish Tax Administration maintains an up-to-date list of PSPs.

The CESOP report is based on the CESOP XML schema and the related User Guide published by the European Commission, which can be found at [Central Electronic System of Payment information \(CESOP\) \(europa.eu\)](https://ec.europa.eu/economy_finance/central-electronic-system-payment-information-cesop). These instructions for application describe from a technical perspective how PSPs report data to the Finnish Tax Administration in accordance with the schema and the business rules.

XML schema validations and XML example documents that meet the Finnish Tax Administration's M/O (Mandatory/Optional) terms are attached herein. The schema version valid at each time is applied to reporting. Only one schema per data flow is used in the Ilmoitin.fi reporting service.

These instructions apply to annual reports submitted after 1 January 2024. Instructions issued by the Finnish Tax Administration must be complied with in reporting. More information on the reporting obligations of PSPs can be found on the page CESOP - vero.fi.

The structures, elements, Ilmoitin.fi checks and submitting procedures defined in these instructions are valid in the Ilmoitin.fi service's test environment (<https://testi.ilmoitin.fi/>) from 25.4.2024 onwards. In the production environment ([www.ilmoitin.fi](http://www.ilmoitin.fi)), the structures, elements and Ilmoitin.fi checks are valid from 29.4.2024 onwards. Reports can be submitted in the production environment from 1 April 2024.

## 1.1 Document reading instructions

This document is primarily aimed at **CESOP report producers**.

The characters in the lower right-hand corner of each element carry the following meanings:

- 0...∞: the element can be repeated from 0 to n times.

- 1...∞: the element can be repeated from 1 to n times.

An element highlighted with a uniform line means a mandatory element, which must always be included in the report. If an element is highlighted with a dashed line, it is voluntary in the schema. However, a voluntary element can be mandatory in certain situations, in which case the element must carry information. As a result, the existence and content of the element will be checked in the Ilmoitin.fi service.

## 2 Ilmoitin.fi service

**CESOP** reports can only be submitted electronically through the Ilmoitin.fi service. The Ilmoitin.fi service is available as a browser-based service and a Web Services API. The Ilmoitin.fi service validates the structural and formal correctness of reports and returns any errors/messages after it has checked them. The checks carried out in the Ilmoitin.fi service are described in section 9.

The correctness of content and compliance with business rules are validated by the CESOP. The validation result returned by the CESOP is transmitted to the customer or submitter of the report via the Ilmoitin.fi service. The submitter of the report is responsible for checking the validation result they receive in the Ilmoitin.fi service and making corrections to the reports as necessary.

Testing and production environments of the Ilmoitin.fi service are available. The testing environment's browser-based service is available at <https://testi.ilmoitin.fi/>. The production environment is available at [www.ilmoitin.fi](http://www.ilmoitin.fi). You can request the addresses of the Web Services APIs by emailing [tamo.tk@vero.fi](mailto:tamo.tk@vero.fi).

Electronic identification is required to submit data. You can check the identification method required for each data flow and information about the point of the data flow in which the authorisation is verified [here](#).

### 2.1 Technical factors related to files

The maximum file size is 100 MB. If the file size exceeds 100 MB, the information must be divided into files under 100 MB. If the reported information is divided into several files, or reports, each report must have a unique MessageRefId and each report is considered a new report (CESOP100). It is recommended that consecutive numbers are used for the MessageRefId and DocRefId elements.

UUID ver. 4 generator is used to generate MessageRefId and DocRefId in order to ensure uniqueness. You can find the generator for example here: [UUID -generator ver. 4](#).

The reports are UTF-8 encoded. To ensure interoperability, UTF-8-encoded ISO8859-1 characters must be used. In practice, this means that Cyrillic alphabets cannot be used, for example. The file must not contain the Byte Order Mark (BOM) character.

Special characters in the report data must be converted according to the table below.

Character	Description	Presentation format as an entity
&	ampersand	&amp; conversion is mandatory
<	less than	&lt; conversion is mandatory
>	more than	&gt; conversion is mandatory
'	apostrophe	&apos; conversion is mandatory
"	quotation mark	&quot; conversion is mandatory

--	double dash	Doesn't exist, character can't be used on a xml-file
/*	slash asterisk	Doesn't exist, character can't be used on a xml-file
&#	et-symbol hash	Doesn't exist, character can't be used on a xml-file

### 3 File names

The 'PaymentDataBody' file submitted via the Ilmoitin.fi service must be named by the customer/submitter according to the following format:

- <messageType>-<quarter>-<year>-<country-MS>-<psp-id>-<part\_number>\_<MessageRefId>

Examples:

- PMT-Q1-2024-FI-AGRIFRPPXXX-1-1\_f70117d1-6aac-4fb3-a1cc-9b76545ed0d0.xml
- PMT-Q1-2024-FI-6606611-7-1-3\_f70117d1-6aac-4fb3-a1cc-9b76545ed0d5.xml
- PMT-Q1-2024-FI-AB1234567-2-3\_f70117d1-6aac-4fb3-a1cc-9b76545ed0d1.xml
- PMT-Q1-2024-FI-CD9876543-3-3\_f70117d1-6aac-4fb3-a1cc-9b76545ed0d7.xml

If the reported data must be reported in several files, the files are named sequentially, for example:

PMT-Q1-2024-FI-AGRIFIPPXXX-1-3\_f70117d1-6aac-4fb3-a1cc-9b76545ed0d5.xml  
PMT-Q1-2024-FI-AGRIFIPPXXX-2-3\_f70117d1-6aac-4fb3-a1cc-9b76545ed0d1.xml  
PMT-Q1-2024-FI-AGRIFIPPXXX-3-3\_f70117d1-6aac-4fb3-a1cc-9b76545ed0d7.xml

Ilmoitin.fi checks that the file name format is correct and that the MessageRefId in the file name is identical to the MessageRefId in the message.

Ilmoitin.fi adds a timestamp in the format YYYYMMDD to the end of the PMT file or message file submitted by the customer. The name of the validation result message (VLD) returned by the CESOP to the customer is otherwise identical to the name of the PMT message transmitted to the service (that includes the timestamp), but the 'PMT' at the start of the name is changed into 'VLD'.

Examples:

- PMT-Q1-2024-FI-AGRIFRPPXXX-1-1\_f70117d1-6aac-4fb3-a1cc-9b76545ed0d0\_20240415.xml
- VLD-Q1-2024-FI-AGRIFRPPXXX-1-1\_f70117d1-6aac-4fb3-a1cc-9b76545ed0d0\_20240415.xml

### 4 Submitting reports

CESOP reports are submitted in accordance with the Act on payment service providers' obligation to report cross border payments (Laki rajat ylittäviä maksuja koskevasta maksupalveluntarjoajien tiedonantovelvollisuudesta) and the 29 § of the Act on assessment procedure for self-assessed taxes (Laki oma-aloitteisten verojen verotusmenettelystä 768/2016). The report is submitted every quarter, and the first report will be submitted for the payment year 2024. At the latest, the report must be submitted within one month of the end of the reporting period.

1 Jan to 31 Mar (by 30 Apr)  
1 Apr to 30 Jun (by 31 Jul)  
1 Jul to 30 Sep (by 31 Oct)  
1 Oct to 31 Dec (by 31 Jan)

According to the Act on payment service providers' obligation to report cross border payments the PSP has the obligation to keep the data reported in electronic format for three (3) calendar years after the end of the calendar year in which the payment was dated.

## 5 Nil reporting

If a PSP has no payment data to report, submitting a nil report is recommended for the relevant reporting period.

Nil reports are submitted by entering the report information and the PSP's identity information in the MessageSpec element, and by entering 'CESOP102' as the value of the MessageTypeIndic element.

In nil reporting, the Ilmoitin.fi service checks that the file structure contains the PaymentDataBody element but no ReportedPayee elements. Nil reporting examples are presented in the file 'Nollailmoitus.xml'.

## 6 Corrections

Corrections are always submitted using the schema valid at the time of the correction. The original report and the corrected report must be submitted via the Ilmoitin.fi service.

The ValidationResult message returned by the CESOP uses CorrMessageRefIdn to indicate which previous report the correction request applies to and DocRefIdn to indicate which ReportedPayee element the correction request applies to.

Corrections are made for each ReportedPayee element. ReportedPayee elements that were reported correctly previously may not be reported again in a correction report. However, the correction report must include all transactions (ReportedTransaction data) of the reported payee (ReportedPayee) even if the correction applies to only some of the transactions.

After an error is detected, you should make the corrections on your initiative, and send them as soon as possible. However, it is important not to send them before you receive the ValidationResult message. Nevertheless, you can submit a new report (CESOP100) to send any data that you have not submitted earlier or any data missing from the original report.

Using the MessageTypeIndic element values in a correction report:

- **CESOP100**: new report
- **CESOP101**: correction or deletion report for correcting or deleting individual elements of previously reported information
- **CESOP102**: used for nil reporting when there is no payment data to report

### DocTypeIndic

- **CESOP1**: new Data – always used when submitting new information, which has not previously been submitted or which has previously been deleted
- **CESOP2**: corrected Data – used when previously submitted information is corrected
- **CESOP3**: deletion of Data – used when previously submitted information is deleted

The DocTypeIndic values CESOP2 and CESOP3 may only be used for correction and deletion reports (MessageTypeIndic="CESOP101"). Correction and deletion reports may have the values CESOP2 and/or CESOP3, but no new data with the value CESOP1. Payment data is not reported with the DocTypeIndic value CESOP3.

The ValidationResult message can have the values VALIDATED, PARTIALLY REJECTED or FULLY REJECTED (see [8.3 ValidationResult](#)).

**VALIDATED**: The CESOP has accepted the message and all data is saved.

- You can make corrections by sending a correction to a previous report, even if it is a report that CESOP has already accepted (VALIDATED). You need to include a new MessageRefId to your correction report, and there must be a CorrMessageRefId that refers to the report concerned by the corrections, i.e. the report you had sent previously. If you have payee data that needs to be corrected, include a new DocRefId, and the CorrDocRefId should refer to the payee data concerned by the corrections.

**PARTIALLY REJECTED**: The CESOP has rejected some reported payees. Validated payees have been saved.

- If the ValidationResult is PARTIALLY REJECTED for a reported payee, you need to send a correction that covers all the payees with transactions that contained errors. You need to include a new MessageRefId to your correction reports, and there must be a CorrMessageRefId that refers to the report concerned by the corrections, which you had sent previously. The payee data being corrected is submitted with a new DocRefId and the CorrDocRefId should refer to the payee data now being corrected. If a correction report is 'PARTIALLY REJECTED', to correct the report, refer to it with the CorrMessageRefId and to the payee data to be corrected with the CorrDocRefId.

**FULLY REJECTED**: The CESOP has rejected the entire message.

- If the ValidationResult is FULLY REJECTED, the report cannot be corrected and the data must be resubmitted with a new report (CESOP100 and with a new MessageRefId and new DocRefIds). If a previously submitted correction report is returned as FULLY REJECTED, the new correction report must still refer to the original report (the same CorrMessageRefId) and the originally reported payee data (the same CorrDocRefIds).

## 7 XML schema structure

The structures in the EC CESOP Schema Used Guide requiring additional instructions and the checks carried out by the Ilmoitin.fi service (hereinafter 'Ilmoitin') outside the XML schema are described in this section.

A more detailed description can be found at [CESOP – XSD User Guide](#)



## 8 CESOP

The CESOP – XSD User Guide has a general description of the CESOP schema. This section describes the technical part of the report at a national level.

The PSPs send their reporting data with the PaymentDataBody root element every quarter.

The CESOP returns a message according to the ValidationResult element via Ilmoitin to the PSP or the report submitter. If there were content or business rule errors in the PaymentDataBody data reported to the CESOP that Ilmoitin did not check, the ValidationResult message will include a report on the errors. If there were no content errors, the message will acknowledge the data as successfully validated. A more detailed description of the content of the ValidationResult element is in [8.3.2 ValidationResult](#).

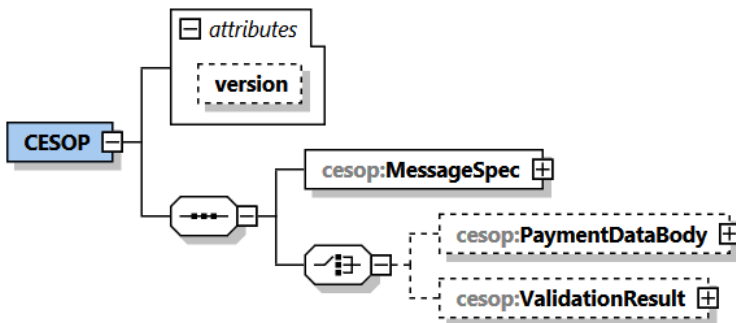

Element	Type	M/O
Version	xs:string	O

- CESOP schema version

### 8.1 MessageSpec

The MessageSpec element has information on the message type.

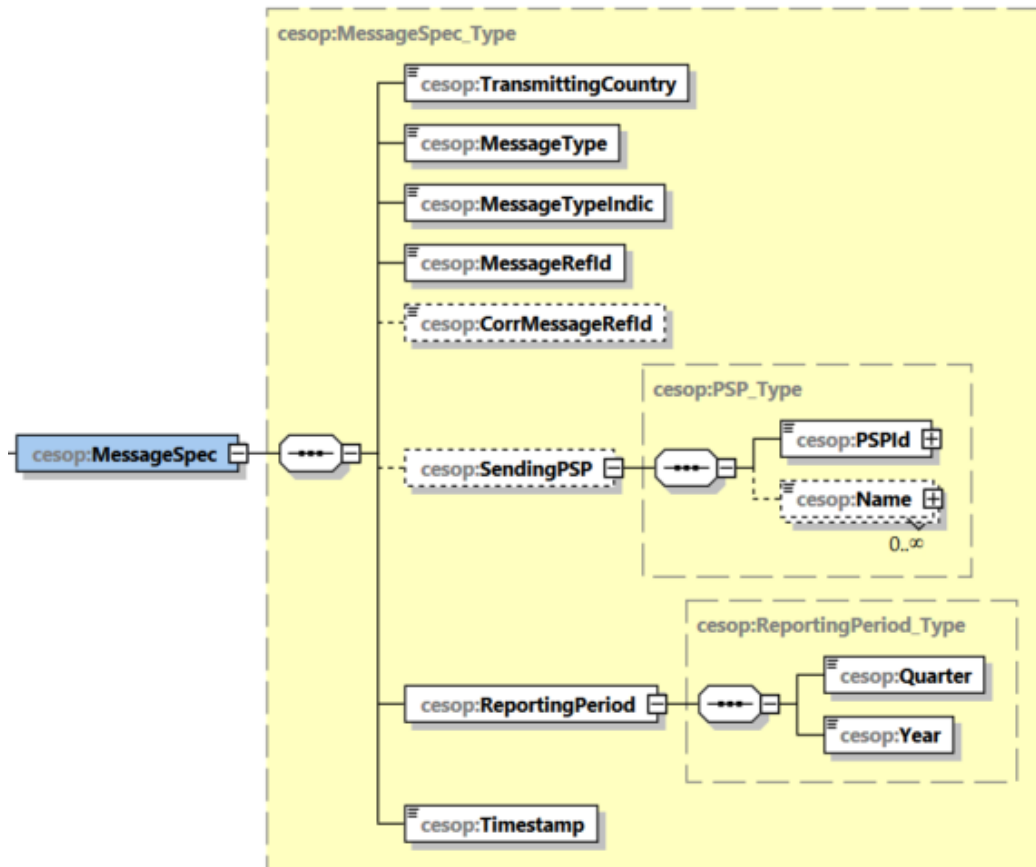

Element	Type	M/O
TransmittingCountry	iso:MSCountryCode_Type	M
<ul style="list-style-type: none"> <li>- The country through which the payment data is transmitted</li> <li>- A two-character country code (ISO-3166-1 Alpha 2 standard)</li> <li>- Always 'FI' (Finland) on the report.</li> </ul>		

Element	Type	M/O
MessageType	cesop:MessageType_Type	M
<ul style="list-style-type: none"> <li>- This element indicates the report type. <ul style="list-style-type: none"> <li>o PMT: <ul style="list-style-type: none"> <li>▪ A PMT message is always sent by the PSP via Ilmoitin</li> <li>▪ If a PMT has been sent, Ilmoitin checks that the message includes data in the PaymentDataBody element.</li> </ul> </li> <li>o VLD: <ul style="list-style-type: none"> <li>▪ VLD messages are always sent by the CESOP to the PSP via Ilmoitin</li> <li>▪ Ilmoitin checks that PSPs do not send VLD messages</li> </ul> </li> </ul> </li> </ul>		

Element	Type	M/O
MessageTypeIndic	cesop:MessageTypeIndic_Type	M
<ul style="list-style-type: none"> <li>- This indicates the type of the report <ul style="list-style-type: none"> <li>o <b>CESOP100</b>: new report</li> <li>o <b>CESOP101</b>: correction or deletion report for correcting or deleting previously reported data</li> <li>o <b>CESOP102</b>: used for nil reporting when there is no payment data to report</li> </ul> </li> </ul>		

Element	Type	M/O
MessageRefID	cm:UUID	M
<ul style="list-style-type: none"> <li>- The unique identifier for the relevant report created by the software that produced the report with UUID version 4</li> </ul>		

- e.g. f70117d1-6aac-4fb3-a1cc-9b76545ed0d0
- Maximum length 36 characters
- The reporting entity must ensure that the MessageRefId is not the same as in any report submitted previously by the PSP. If the reported information is divided into several files, or reports, each report must have a unique MessageRefId
- Ilmoitin checks that the format of the data is correct and that it is unique

Element	Type	M/O
CorrMessageRefID	cm:UUID	O/M

- MessageRefId for reports to be corrected or deleted
  - e.g. f70117d1-6aac-4fb3-a1cc-9b76545ed0d0
- UUID version 4
- Maximum length 36 characters
- The CorrMessageRefId is only entered when previously submitted reports are corrected or deleted (CESOP101)
  - Ilmoitin checks that the CorrMessageRefId is only entered if the MessageTypeIndic is CESOP101
- Ilmoitin checks that the format is correct
- Ilmoitin checks that an original report can be found with the MessageRefID of the correction or deletion report

Element	Type	M/O
SendingPSP	cesop:PSP_Type	O

- Unambiguously identifies the PSP who submits the data of its 'subsidiaries' to the Finnish Tax Administration in a centralised manner.
- This element must be left out if the SendingPSP and ReportingPSP are the same entity.

Element	Attribute	Type	M/O
PSPId	cesop:PSPIdType	cm:StringMin1Max200_Type	M

- BIC or other company identifier that unambiguously identifies the PSP
- For Finnish PSPs, BIC or Business ID
- cesop:PSPIdType
  - BIC
    - <cesop:PSPId PSPIdType="BIC">AGRIFIHH</cesop:PSPId>
  - Other
    - Finnish Business ID
      - <cesop:PSPId PSPIdType="Other">6606611-7</cesop:PSPId>
    - If a BIC or Business ID cannot be entered, a VAT or TIN identifier can be used
      - <cesop:PSPId PSPIdType="Other">AB1234567</cesop:PSPId>
      - <cesop:PSPId PSPIdType="Other">CD9876543</cesop:PSPId>

Element	Attribute	Type	M/O
Name	cm:nameType	cm:StringMin1Max200_Type	O

- PSP name
- cesop:nameType values
  - BUSINESS
  - LEGAL
  - OTHER
  - PERSON
  - TRADE

Element	Type	M/O
ReportingPeriod	cesop:ReportingPeriod_Type	M

- This element is used to report the quarter and the year to which the payment data submitted by the PSP pertains

Element	Type	M/O
Quarter	Quarter_Type	M

- o This element is used to report the quarter to which the payment data pertains
- o Values
  - 1 = 1 Jan to 31 Mar
  - 2 = 1 Apr to 30 Jun
  - 3 = 1 Jul to 30 Sep
  - 4 = 1 Oct to 31 Dec

Element	Type	M/O
Year	Year_Type	M

- o This element is used to report the year to which the payment data pertains

Element	Type	M/O
Timestamp	cm:dateTimeWithRequiredTimeZone	M

- The submitter enters the report creation time with millisecond precision.
- Timestamp can be submitted using any time zone as long as the used time zone is given.
  - o 2024-01-17T09:30:45.123+02:00 (Finnish wintertime)
  - o 2024-01-17T09:30:45.123+03:00 (Finnish summertime)
  - o 2024-01-17T09:30:45.123Z (time given in UTC)

## 8.2 PaymentDataBody

The PaymentDataBody element has information on the PSP, payees and transactions per payee

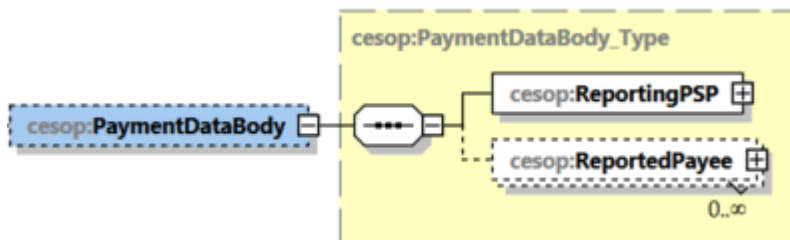

### 8.2.1 ReportingPSP

The ReportingPSP element has information on the PSP that reports the payment data to the Finnish Tax Administration.

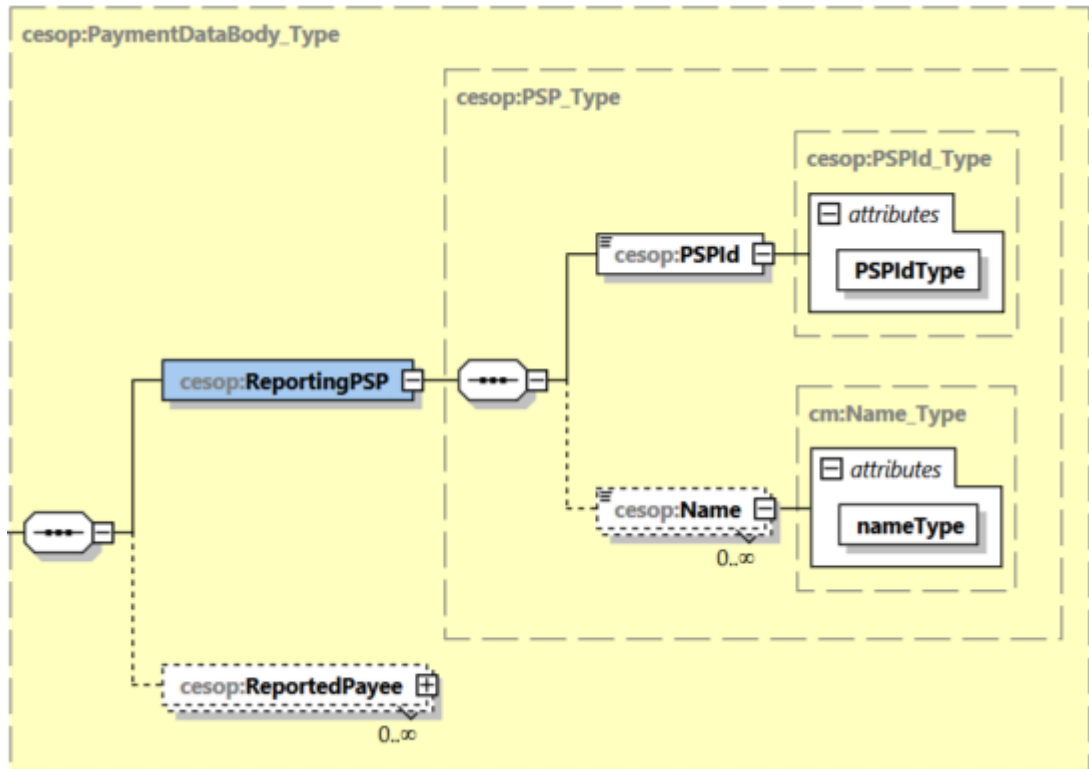

Element	Attribute	Type	M/O
PSPId	cesop:PSPIdType	cm:StringMin1Max200_Type	M

- The BIC or other identifier that unambiguously identifies the reporting PSP
- If the BIC does not identify the PSP, another identifier must be used (Other)
- If the PSP has Finnish Business ID it should be reported in this Element
- cesop:PSPIdType
  - o BIC
    - <cesop:PSPId PSPIdType="BIC">AGRIFIHH</cesop:PSPId>
  - o Other
    - Finnish Business ID
      - <cesop:PSPId PSPIdType="Other">6606611-7</cesop:PSPId>
    - If a BIC or Business ID cannot be entered, a VAT or TIN identifier or any other identifier which unambiguously identifies the PSP can be used
      - <cesop:PSPId PSPIdType="Other">AB1234567</cesop:PSPId>
      - <cesop:PSPId PSPIdType="Other">CD9876543</cesop:PSPId>

Element	Attribute	Type	M/O
Name	cm:nameType	cm:StringMin1Max200_Type	O

- PSP name
- Name must be provided when other than Finnish Business ID is provided in the PSPId element.
- Even in other situations it is recommended that the name is provided.
- cesop:nameType
  - o BUSINESS
  - o LEGAL
  - o OTHER
  - o PERSON
  - o TRADE

### 8.2.2 ReportedPayee

The ReportedPayee element has information on the payees and transactions per payee.

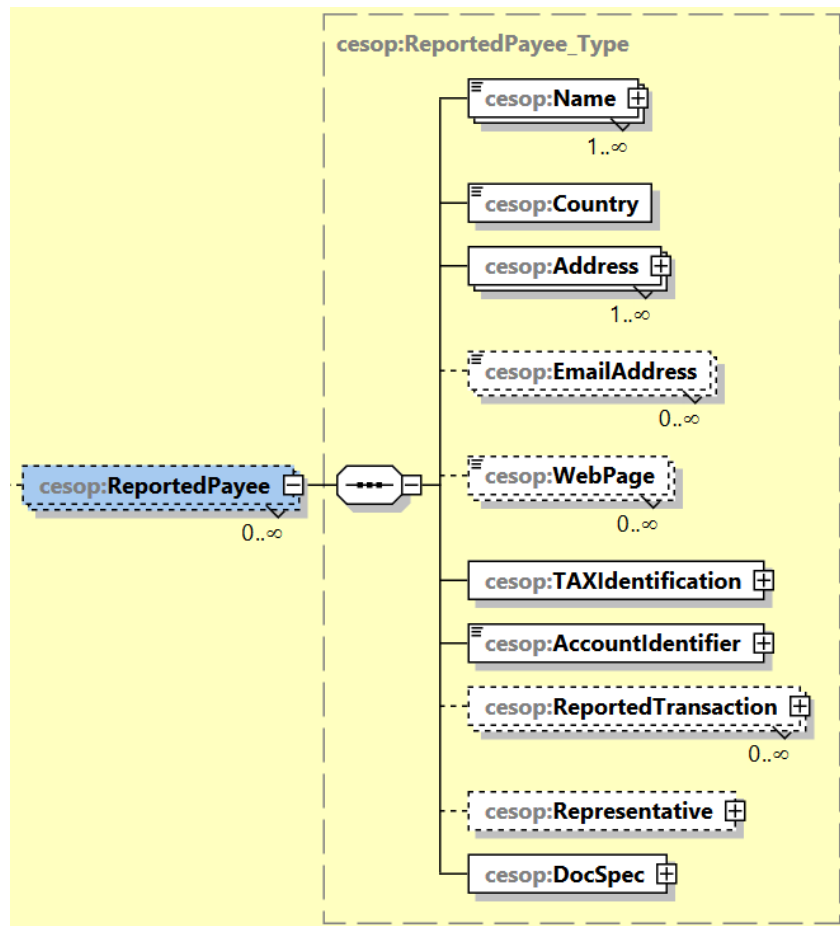

Element	Attribute	Type	M/O
Name	cm:nameType	cm:StringMin1Max200_Type	M

- This element is used to report the name or trade name of the reported payee
- This element is used to report all payee names as they are in the PSP's data.
- cesop:nameType
  - o BUSINESS
  - o LEGAL
  - o OTHER
  - o PERSON
  - o TRADE

Element	Type	M/O
Country	iso:CountryCode_Type	M

- This element is used to report the country of the location of the payee

Element	Type	M/O
Address	cm:Address_Type	M

- All payee addresses (e.g. postal address) as they are in the PSP's data.
- This information must be reported if it is available.
- If a non-disclosure of personal data has been registered in the Population Information System for the payee, the address subject to the non-disclosure shall not be reported, but instead any other public or from the payee's perspective safe address. In Finland contact address is a safe address that can stay as a public address in the Population Information System. If the PSP doesn't have knowledge about the contact address nor any other safe address for the client, following information shall be given in the AddressFree element: "Non-disclosure for personal safety reasons based on domestic legislation".
- See [8.2.3 Address elements](#)

Element	Type	M/O
EmailAddress	cm:Email_Type	O

- Payee email address.

Element	Type	M/O
WebPage	cm:WebPage_Type	O

- Payee website

Element	Type	M/O
TAXIdentification	cesop:TAXIdentifier_Type	M

- Any payee VAT identifier or other national tax number. This information must be reported if it is available. Otherwise, the element can be empty.
- This element is used to report all available payee tax identifiers.

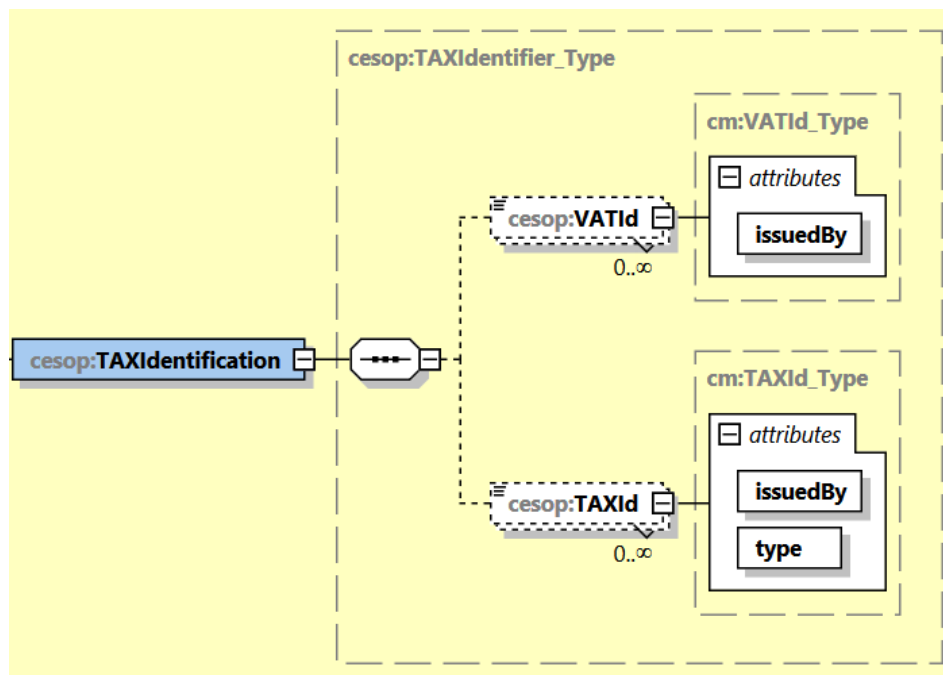

Element	Attribute	Type	M/O
VATId	issuedBy	cm:VATId_Type	O

- Payee's validated VAT identifier in an EU Member State. You can verify the VAT identifier on the European Commission's web page [VIES VAT number validation](#). A non-validated VAT identifier is given in element TAXId, value UNCONFIRMED VAT.
  - o issuedBy
    - Mandatory if VATId element is entered
  - o <cesop:VATId issuedBy="FI">12345678</cesop:VATId>

Element	Attribute	Type	M/O
TAXId	issuedBy type	cm:TAXId_Type	O

- All payee VAT identifiers known to the PSP
- A Business ID (TIN) or a Finnish Personal ID (TIN) is primarily entered for a Finnish payee
- issuedBy country code (ISO-3166-1 Alpha 2 standard)
  - o Mandatory if the TAXId element is entered
- Type
  - o Type of tax identifier
  - o Values
    - UNCONFIRMED\_VAT: Unconfirmed or National VAT identifier.
    - TIN: Tax Identification Number (TIN).
    - IOSS: Import One Stop Shop (IOSS-Id).

- OTHER: Other tax identifier.
  - Mandatory if the TAXId element is entered
- e.g. <cesop:TAXId issuedBy="FI" type="TIN">1234567-8</cesop:TAXId>

Element	Attribute	Type	M/O
AccountIdentifier	CountryCode Type	cesop:AccountIdentifier_Type	M/O

- IBAN of the payee payment account or other identifier that unambiguously identifies the payee and gives the payee's location
- If the payee has several IBAN numbers, the account number where the payment has been sent to shall be reported
- In the first place, IBAN must be reported. In case IBAN is not available, another identifier must be reported. The other identifier can be a seller ID, information of an E-money account, SWIFT code or a national bank account number. If the IBAN for the payment account and another identifier are contradictory, the PSP can use the identifier which best reflects the actual location.
- Enter the identifier without any spaces.
- If the information about Representative has been submitted, AccountIdentifier element shall be left empty.

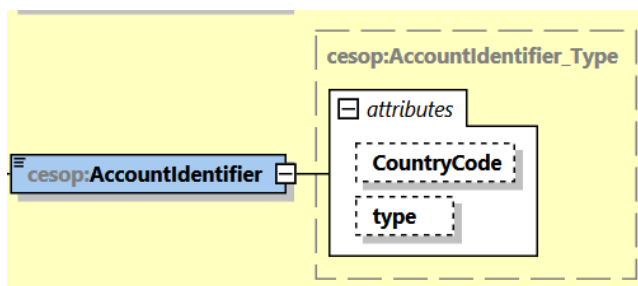

- Attributes
  - CountryCode
    - Country code of the country that issued the identifier.
    - Location country code (ISO-3166 Alpha 2).
  - Type
    - Type of location identifier
      - IBAN
      - OBAN
      - Other

Element	Type	M/O
ReportedTransaction	cesop:ReportedTransaction_Type	O

- Parent element listing all the received payments and payment refunds for the given payee reported by the PSP.
- See [8.2.2.1 ReportedTransaction](#)

Element	Type	M/O
Representative	cesop:PSP_Type	O

- BIC or any other identifier that unambiguously identifies the PSP acting on behalf of the payee and gives its location when the payee received funds but does not have a payment account.
- When this data is entered, AccountIdentifier element shall be left empty.

Element	Type	M/O
---------	------	-----



Representativeld	cesop:PSPIdType	M
------------------	-----------------	---

- BIC or any other identifier that unambiguously identifies the PSP acting on behalf of the payee.
- PSPIdType arvot
- cesop:PSPIdType
  - o BIC
    - <cesop:PSPId PSPIdType="BIC">AGRIFIHH</cesop:PSPId>
  - o Other
    - Finnish Business ID
      - <cesop:PSPId PSPIdType="Other">6606611-7</cesop:PSPId>
    - If a BIC or Business ID cannot be entered, a VAT or TIN identifier can be used
      - <cesop:PSPId PSPIdType="Other">AB1234567</cesop:PSPId>
      - <cesop:PSPId PSPIdType="Other">CD9876543</cesop:PSPId>

Element	Attribute	Type	M/O
Name	cm:NameType	cm:StringMin1Max200_Type	O

- The name of the PSP acting on behalf of the payee.
- cesop:nameType values
  - o BUSINESS
  - o LEGAL
  - o OTHER
  - o PERSON
  - o TRADE

Element	Type	M/O
DocSpec	cm:DocSpec_Type	M

- This element is used to report an individual payee and the details of its transactions
- See [8.2.4 DocSpec element](#)

### 8.2.2.1 ReportedTransaction

All the received payments and payment refunds for a given payee reported by the PSP are listed in the ReportedTransaction element.

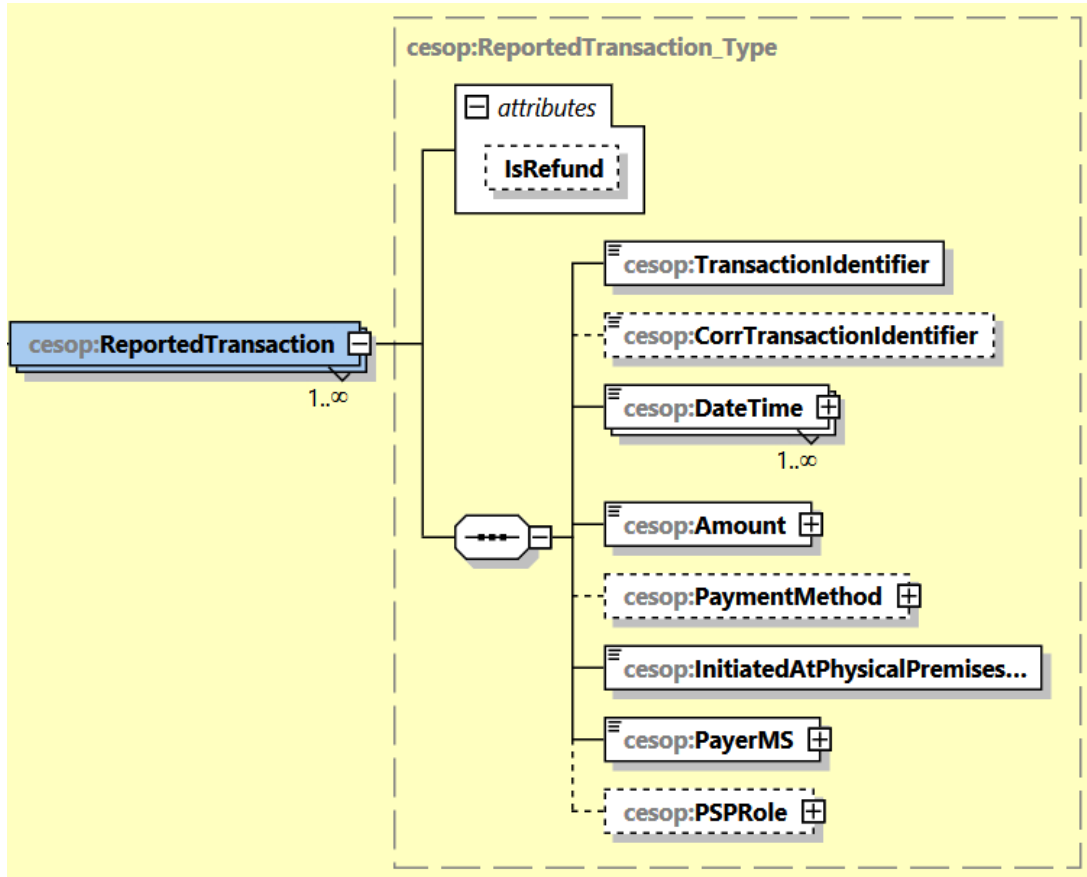

Element	Attribute	Type	M/O
IsRefund	Refund_type	Boolean	O

- This element is used to report whether the transaction is a payment or a refund
- If the element is not entered, it is set as 'false' by default
  - o payment=false
  - o refund=true

Element	Type	M/O
TransactionIdentifier	cm:StringMin1Max40_Type	M

- The PSP's identifier/reference that is unique to each reporting period in the PSP's system

Element	Type	M/O
CorrTransactionIdentifier	cm:StringMin1Max40_Type	O

- Reference used for refunds
- Used in the case of a 'transaction refund' in connection with the relevant 'received payment'.

Element	Attribute	Type	M/O
DateTime	TransactionDateType	cm:TransactionDate_Type	M

- This element is used to indicate the date and time of a payment or refund
- Payment date transaction type
  - CESOP701 Execution Date
  - CESOP702 Clearing Date
  - CESOP703 Authorisation Date
  - CESOP704 Purchase Date
  - CESOP709 Other Date

Example: <cesop:DateTime transactionDateType="CESOP701">2024-04-21T00:51:51Z</cesop:DateTime>

Element	Attribute	Type	M/O
---------	-----------	------	-----

Amount	Currency	Amount	M
--------	----------	--------	---

- This element is used to report the total amount of the payment or refund with two decimals.
- The value must be:
  - o positive in the case of a payment
  - o negative in the case of a refund
- The 'Currency' attribute is used to indicate the currency of the payment or refund.

Element	Type	M/O
PaymentMethod	cm:PaymentMethod_Type	O

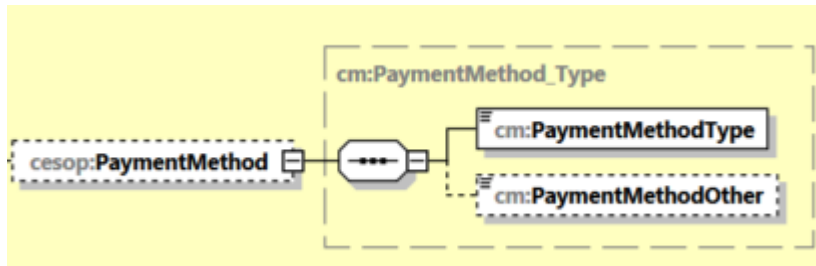

Element	Type	M/O
PaymentMethodType	cm:PaymentMethodType_Type	M

- Payment method
- Values
  - o Bank transfer
  - o Card payment
  - o Direct debit
  - o E-money
  - o Intermediary
  - o Marketplace
  - o Money Remittance
  - o Other

Element	Type	M/O
PaymentMethodOther	cm:StringMin1Max200_Type	O

- Must be entered if the value entered for payment method is 'Other'
- Includes a description if the value entered for payment method is 'Other'

Element	Type	M/O
InitiatedAtPhysicalPremisesOfMerchant	Boolean	M

- This element is used to indicate whether the transaction took place at a physical location of the payee or online.
- Values
  - o 'True' for a physical location
  - o 'False' for online

Element	Attributes	Type	M/O
PayerMS	PayerMSSource	cesop:PayerIdentifier_Type	M

- The payee's Member State or refund destination Member State, which is always an EU country
- PayerMSSource values
  - o IBAN
  - o OBAN
  - o Other

Element	Type	M/O
PSPRole	cm:PSPRole_Type	O

- The role of the PSP acting on behalf of the payee.

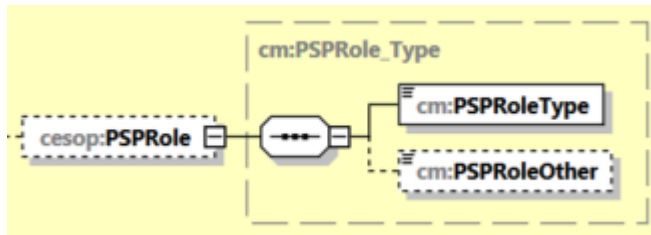

Element	Type	M/O
PSPRoleType	cm:PSPRole_Type	M

- Values
  - o Acquirer
  - o E-money provider
  - o E-payment
  - o e-Wallet provider
  - o Four party card scheme
  - o Issuer of payment instruments
  - o Money Transfer operator
  - o Other
  - o Payment collector
  - o Payment Processor
  - o Three party card scheme

Element	Type	M/O
PSPRoleOther	cm:StringMin1Max200_Type	O

- Information to be reported if the value entered for the PSP type is 'Other'
- Includes a description if the value entered for the PSP type is 'Other'

### 8.2.3 Address elements

Addresses are reported with the AddressFix or AddressFree element

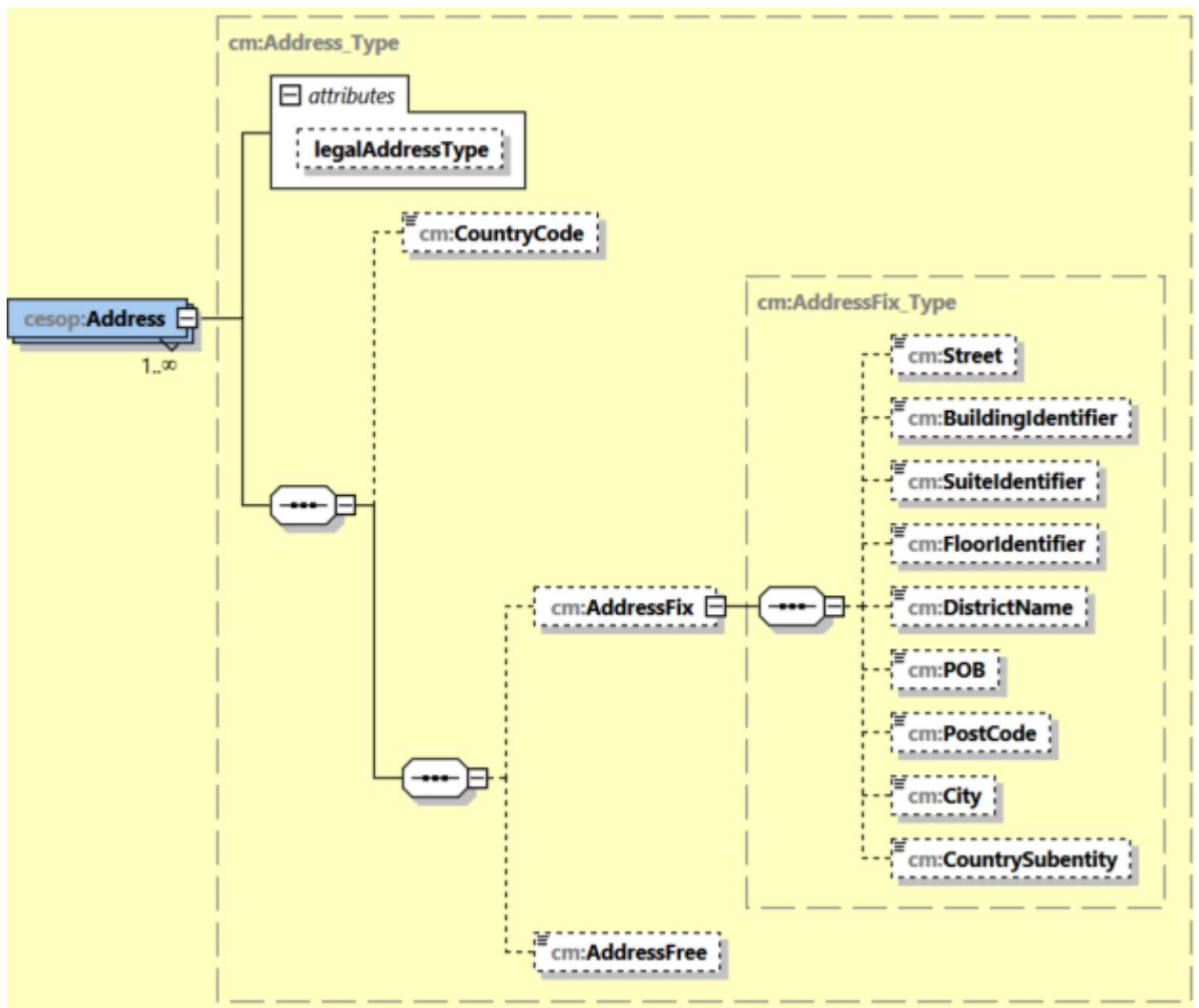

Element	Attribute	Type	M/O
Address	legalAddressType	cm:LegalAddressType_EnumType	O

- Address type
  - o CESOP301 = residential or business
  - o CESOP302 = residential
  - o CESOP303 = business
  - o CESOP304 = registered office
  - o CESOP309 = unspecified

Element	Type	M/O
CountryCode	iso:CountryCode_Type	O

- Address country
- A two-character country code (ISO-3166-1 Alpha 2 standard)

### 8.2.3.1 AddressFix

Element	Type	M/O
Street	cm:StringMin1Max200_Type	O

- Street name

Element	Type	M/O
BuildingIdentifier	cm:StringMin1Max200_Type	O

- House/building number

Element	Type	M/O
SuiteIdentifier	cm:StringMin1Max200_Type	O

- Apartment number or equivalent

Element	Type	M/O
FloorIdentifier	cm:StringMin1Max200_Type	O

- Floor

Element	Type	M/O
DistrictName	cm:StringMin1Max200_Type	O

- District

Element	Type	M/O
POB	cm:StringMin1Max200_Type	O

- P.O. Box

Element	Type	M/O
PostCode	cm:StringMin1Max200_Type	O

- Postal code

Element	Type	M/O
City	cm:StringMin1Max200_Type	O

- City/municipality

Element	Type	M/O
CountrySubentity	cm:StringMin1Max200_Type	O

- State or equivalent

### 8.2.3.2 AddressFree

The AddressFree element is used if the address cannot be reported with the AddressFix element.

Element	Type	M/O
AddressFree	cm:StringMin1Max1000_Type	O

- Free-text address field
- It is recommended that the address is entered in the format: street, city/town and postal code.
- Secondary to AddressFix
- If all address information has been entered using the AddressFix element, the AddressFree element will not be included in the report.

### 8.2.4 DocSpec element

The DocSpec element includes the payee data element type (DocTypeIndic) and the data structure identifier information (DocRefId).

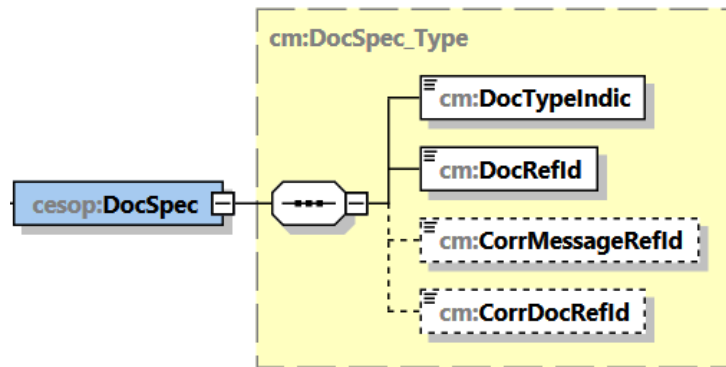

Element	Type	M/O
DocTypeIndic	cm:DocTypeIndic_EnumType	M

- Type of report
- Values
  - CESOP1
    - o This is always used when submitting new information, which has not been submitted previously or which has previously been deleted.
  - CESOP2
    - o This is used when previously submitted information is corrected.
  - CESOP3
    - o This is used when previously submitted information is deleted.
- DocTypeIndic values CESOP2 and CESOP3 may only be used for correction reports (MessageTypeIndic="CESOP101").
- New information with the DocTypeIndic value CESOP1 cannot be entered in CESOP101 correction reports.

Element	Type	M/O
DocRefId	cm:UUID	M

- The unique identifier for the relevant data structure created by the software that produced the report with UUID version 4
- Ilmoitin checks that the format of the data is correct and that it is unique

Element	Type	M/O
CorrMessageRefId	cm:UUID	O

- Not in use

Element	Type	M/O
CorrDocRefId	cm:UUID	O

- The CorrDocRefID element refers to the DocRefId element of a corrected or deleted data collection.
- This data must be reported if DocTypeIndic = CESOP2 or CESOP3
- Only entered when correcting a previously submitted report. A separate DocRefID is also entered for the correction message
- Ilmoitin checks that the information has been entered when DocTypeIndic = CESOP2 or CESOP3.

### 8.3 ValidationResult

The ValidationResult returned by the CESOP to the customer/submitter via Ilmoitin has two elements, MessageSpec and ValidationResult.

#### 8.3.1 MessageSpec

Element	Type	M/O
---------	------	-----

TransmittingCountry	iso:MSCountryCode_Type	M
---------------------	------------------------	---

- The country through which the payment data was transmitted
- A two-character country code (ISO-3166-1 Alpha 2 standard)

Element	Type	M/O
MessageType	cesop:MessageType_Type	M

- Type of report
- The message returned by CESOP always has 'VLD'.

Element	Type	M/O
MessageTypeIndic	cesop:MessageTypeIndic_Type	M

- This indicates the type of the relevant validated report
  - o CESOP100
  - o CESOP101
  - o CESOP102

Element	Type	M/O
MessageRefID	cm:UUID	M

- Unique identifier of the validation message
- The MessageRefId of the VLD message may not be used when a PMT correction or deletion report is submitted

Element	Type	M/O
CorrMessageRefID	cm:UUID	M

- The unique identifier of the validated PMT message

Element	Type	M/O
ReportingPeriod	cesop:ReportingPeriod_Type	M

- The quarter and the year of the validated message to which the payment data submitted by the PSP pertains.

Element	Type	M/O
Timestamp	cm:dateTimeWithRequiredTimeZone	M

- Validation message generation timestamp

### 8.3.2 ValidationResult

The ValidationResult element returned to the PSP by CESOP includes a validation report on the submitted report. The validation result can be VALIDATED, PARTIALLY REJECTED or FULLY REJECTED. Ilmoitin can check the correctness of the format of reports submitted via the service, but it cannot detect all content errors. For example, Ilmoitin can check that the MessageRefId and DocRefId are unique. However, reports can be submitted to the CESOP via the reporting channels of other countries subject to the reporting requirement with generated identifiers that have the same content as an identifier submitted via Ilmoitin. In this case, the CESOP validation message will include errors.



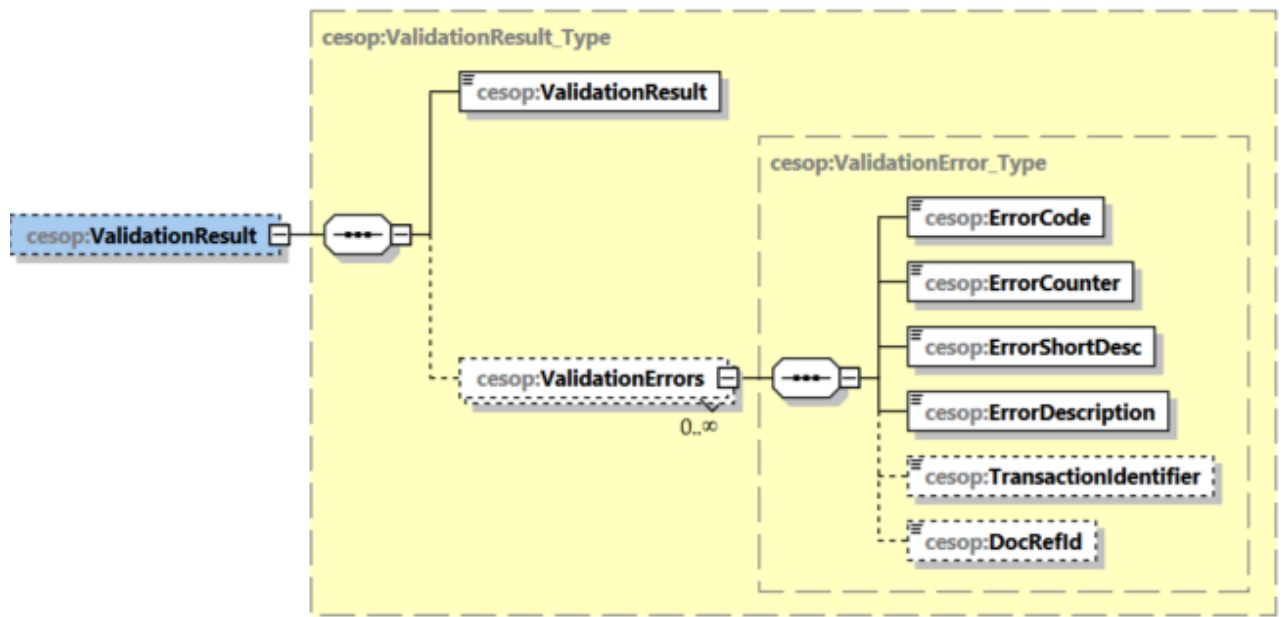

Element	Type	M/O
ValidationResult	cesop:ValidationResultType_Type	M

- VALIDATED: The message was validated and saved to CESOP
- PARTIALLY REJECTED: The message was partially rejected. Rejected payee data identified with their DocRefIds are reported with the ValidationErrors element and they must be corrected.
- FULLY REJECTED: The message was fully rejected. The data must be resubmitted in a new report.
- See [6. Corrections](#)

### 8.3.3 ValidationErrors

The CESOP returns errors via Ilmoitin to the PSP if it detects content errors in the submitted PaymentData that the checks carried out by Ilmoitin did not detect or that Ilmoitin cannot check.

Element	Type	M/O
ErrorCode	cesop:ErrorCode_Type	M

- Error code related to errors detected during the validation of the related payment data message.
- Values

Error code	Description
10010	The MessageRefID is not unique – Ilmoitin checks for national reports
10020	The Timestamp element refers to an incorrect value – Ilmoitin checks for national reports
10030	The value for ReportingPeriod may not be earlier than 1/2024 – Ilmoitin checks for national reports
10040	Incorrect CorrMessageRefID – Ilmoitin checks for national reports
10050	Incorrect format of the MessageRefID element – Ilmoitin checks for national reports
10060	Incorrect format of the CorrMessageRefID element – Ilmoitin checks for national reports
10070	Original payment data message can only include new data – checked by the CESOP
10080	A correction message can only contain corrections and/or deletions – checked by the CESOP

10090	Incorrect message type – Ilmoitin checks for national reports
10100	The reporting period cannot be updated, in a correction message, the reporting period must be identical to the reporting period of the correlated message – checked by the CESOP
10110	CorrMessageRefId used incorrectly in MessageSpec – Ilmoitin checks for national reports
20010	DocRefID is not unique – Ilmoitin checks for national reports
20020	DocRefID is not unique in the CESOP – Ilmoitin checks for national reports, but otherwise checked by the CESOP
20030	Incorrect DocRefID format – Ilmoitin checks for national reports
20040	Incorrect value for the CorrDocRefId element – Ilmoitin checks for national reports
20050	The element CorrDocRefId is used for new data – Ilmoitin checks for national reports
20060	Missing CorrDocRefId – Ilmoitin checks for national reports
20070	CorrDocRefId no longer valid – checked by the CESOP
20100	Invalid PSP's BIC format – checked by the CESOP
20110	Missing reported payee – checked by the CESOP
30010	Company identifier of the PSP acting on behalf of a payee is the same as the company identifier of the reporting PSP – The check will be removed from the CESOP in May 2024.
40010	Reported transaction is not a cross-border transaction – Ilmoitin checks for national reports
40020	IBAN format incorrect – checked by the CESOP
40030	IBAN is not valid – checked by the CESOP
40040	Payee reported, a ReportedPayee element included on a nil report – Ilmoitin checks for national reports
40050	The ReportedTransaction is element missing – checked by the CESOP
40060	Discrepancy in the 'AccountIdentifier' attributes – checked by the CESOP
40070	Invalid BIC format for the PSP acting on behalf of the payee – checked by the CESOP
40080	Discrepancy between 'AccountIdentifier' and 'Representative' – checked by the CESOP
45010	Incorrect value of the 'IsRefund' element in the 'AmountCurrency' element – checked by the CESOP
45020	The payment data message has data from several periods – checked by the CESOP
45030	The 'DateTime' element refers to an incorrect value – checked by the CESOP
45040	The 'TransactionIdentifier' element is not unique within the Payment Data message – checked by the CESOP
45050	The 'TransactionIdentifier' element is not unique within the system – checked by the CESOP
45060	Value for the 'Amount' element is zero – Ilmoitin checks for national reports
45080	Same transaction date provided more than once – checked by the CESOP
50080	Too many errors detected – checked by the CESOP
99999	Undetermined error – checked by the CESOP (a temporary error code for undetermined, unexpected errors)

Element	Type	M/O
ErrorCounter	integer	M

- Shows the number of times the same error is repeated in the PaymentData message

Element	Type	M/O
ErrorShortDesc	cm:StringMin1Max100_Type	M

- A short description of the error

Element	Type	M/O
ErrorDescription	cm:StringMin1Max1000_Type	M

- Description of the error

Element	Type	M/O
TransactionIdentifier	cm:StringMin1Max100_Type	O

- The transaction identifier that indicates the transaction with errors

Element	Type	M/O
DocRefId	cm:UUID	O

- Identifies the payee record in which the error occurs

## 9 CHECKS MADE BY ILMOITIN

In error messages related to PaymentDataBody, you also need to indicate the value that caused the error and indicate the path relating to the element structure where possible.

Some of the checks related to the MessageSpec, MessageRefId, CorrMessageRefId, DocRefId and CorrDocRefId elements are only carried out when logged in to the Ilmoitin.fi service.

Check Added/edited	Information	Description of the check
	Entire record	#The record includes non-permitted characters or character combinations (--,&#,' or /*). #Aineisto pitää sisällään kiellettyjä merkkejä tai merkkiyhdistelmiä (--,&#,' tai /*)
	Entire record	The size of the PaymentData message may not exceed 100 MB PaymentData-sanoman koko saa olla enintään 100 MB
	MessageType	Ilmoitin checks that VLD messages are not sent through it. Ilmoitin tarkistaa, että sen kautta ei yritetä lähettää VLD-tyyppistä sanomaa.  #VLD messages cannot be sent via the Ilmoitin.fi service. 10090 #VLD-tyyppistä sanomaa ei voi lähettää Ilmoitin.fi-palvelun kautta. 10090
	MessageRefId	MessageRefId must be unique. The service checks that no report has been submitted before using the same MessageRefId.  #You are submitting a report with a previously used MessageRefID:[MessageRefID]. 10010 MessageRefId on oltava uniikki. Tarkastetaan, ettei samalla MessageRefId:llä ole lähetetty ilmoitusta aiemmin.  #Olet lähettämässä ilmoitusta jo aiemmin käytetyllä MessageRefID:llä:[MessageRefID]

		<p>10010</p> <p>#MessageRefid format incorrect 10050</p> <p>#MessageRefid ei ole oikean muotoinen 10050</p>
	CorrMessageRefId	<p>#CorrMessageRefid format incorrect 10060</p> <p>#CorrMessageRefid ei ole oikean muotoinen 10060</p>
	CorrMessageRefId	<p>#The entered CorrMessageRefId could not be found in previously submitted records: [CorrMessageRefID] 10040</p> <p>#Annettua CorrMessageRefId:tä ei löydy aiemmin lähettyistä aineistoista: [CorrMessageRefID] 10040</p>
	ReportingPeriod	<p>#ReportingPeriod may not be later than the Timestamp 10020</p> <p>#ReportingPeriod ei voi olla myöhäisempi kuin Timestampin aikaleima 10020</p>
	ReportingPeriod	<p>#ReportingPeriod may not be earlier than 1/2024 10030</p> <p>#ReportingPeriodin arvo ei saa olla aiempi kuin 1/2024 10030</p>
	DocRefId	<p>DocRefId must be unique in the message and system</p> <p>#You are submitting a report with a previous DocRefID:[DocRefID] 20010 20020</p> <p>DocRefId pitää olla uniikki sanomassa ja järjestelmässä</p> <p>#Olet lähettämässä ilmoitusta jo aiemmin DocRefID:llä:[DocRefID] 20010 20020</p> <p>#DocRefid format incorrect 20030</p> <p>#DocRefid ei ole oikean muotoinen 20030</p>
	CorrDocRefId DocTypeIndic	<p>CorrDocRefId can only be entered when DocTypeIndic = CESOP2 or CESOP3. 10080 20050</p> <p>Tiedon CorrDocRefId saa antaa vain kun DocTypeIndic = CESOP2 tai CESOP3 10080 20050</p> <p>Ilmoitin checks that the information has been entered when DocTypeIndic = CESOP2 or CESOP3. 20060</p> <p>Ilmoitin tarkistaa, että tieto on annettu, kun DocTypeIndic = CESOP2 tai CESOP3 20060</p>

	CorrDocRefId	<p>#The entered CorrDocRefId could not be found in previously submitted records:[xx]  #CorrDocRefID xx has already been corrected/deleted.  #CorrDocRefID xx has already been corrected.  10040  20040  #Annettua CorrDocRefId:tä ei löydy aiemmin lähetetyistä aineistoista:[xx]  #CorrDocRefID xx on korjattu/poistettu jo aiemmin  #CorrDocRefID xx on korjattu jo aiemmin  10040  20040</p>
	DocTypeIndic	<p>#A report can only include new information (CESOP1) or corrections and deletions (CESOP2 and CESOP3).  #Ilmoitus saa sisältää vain joko uusia tietoja (CESOP1) tai korjauksia ja poistoja (CESOP2 ja CESOP3).</p>
	MessageTypeIndic DocTypeIndic	<p>#DocTypeIndic values CESOP2 and CESOP3 may only be used for correction reports (MessageTypeIndic = 'CESOP101')  10070  10080  #DocTypeIndic:n arvoa CESOP2 ja CESOP3 saa käyttää vain korjausilmoituksella (MessageTypeIndic = 'CESOP101')  10070  10080</p>
	MessageTypeIndic DocTypeIndic	<p>#The DocTypeIndic value CESOP1 may not be used in correction reports (MessageTypeIndic = 'CESOP101').  10070  10080  #DocTypeIndic:n arvoa CESOP1 ei saa käyttää korjausilmoituksella (MessageTypeIndic = 'CESOP101')  10070  10080</p>
	MessageTypeIndic CorrMessageRefId	<p>#CorrMessageRefId not allowed if MessageTypeIndic is CESOP100  10070  10080  10110  #CorrMessageRefId ei ole sallittu, kun MessageTypeIndic on CESOP100  10070  10080  10110</p>
	CorrDocRefId	<p>#CorrDocRefId must refer to the latest message validated by the CESOP  20070  #CorrDocRefId pitää viitata viimeisimpään CESOPin hyväksymään sanomaan  20070</p>
The check will be removed on 29.4.2024.	<del>ReportingPSP/PSPId Representative/PSPId</del>	<p><del>#Representative may not be the same as PSPId  30010  #Representative ei saa olla sama kuin PSPId  30010</del></p>
	PayerMS CountryCode ReportedPayee CountryCode	<p>#PayerMS CountryCode may not be the same as ReportedPayee CountryCode</p>

		40010 #PayerMS CountryCode ei saa olla sama kuin ReportedPayee CountryCode 40010
	MessageTypeIndic Reported Payee	#Nil reports (MessageTypeIndic = 'CESOP102') may not include ReportedPayee elements 40040 #Nollailmoituksella (MessageTypeIndic="CESOP102" Ei saa antaa ReportedPayee rakenteita 40040
18 Dec 2023	Amount	#Value must be different from 0,00 #Zero value for 'Amount' element 45060 #Määrä pitää olla erisuuri kuin 0,00 #Zero value for 'Amount' element 45060
	ValidationResult	If the validation result of a new report (CESOP100) is 'FULLY REJECTED', a correction report cannot be submitted and the corrected data must be submitted as a new report. Jos uudelle ilmoitukselle (CESOP100) on palautunut 'FULLY REJECTED' validointitulos, ei voi lähettää korjausilmoitusta vaan korjatut tiedot on lähetettävä uutena ilmoituksena.

## 10 NOTIFICATIONS FROM ILMOITIN

Notification added	Data item	Description of the check
--------------------	-----------	--------------------------

## 11 More information and links

XML examples supplementing these instructions are published on the vero.fi website.

[CESOP Validation Module v1.3.0 and corresponding User Manual v2.01](#)