

English translation
original Finnish/Swedish memorandum
has Record Number A191/200/2016

CRS and DAC2 annual information returns

Technical instructions

Table of contents

1	CRS AND DAC2 RETURNS – TECHNICAL INSTRUCTIONS.....	6
1.1	Example files in the XML format	6
1.2	How to read this memorandum.....	7
2	THE ILMOITIN.FI E-SERVICE	8
2.1	Technical requirements for the files to be submitted.....	9
3	FILING A RETURN.....	9
4	FILING A "NIL" RETURN.....	9
5	CORRECTION TO PREVIOUSLY FILED RETURNS	10
6	STRUCTURE OF THE XML SCHEME.....	11
6.1	MessageSpec.....	11
6.1.1	Contact.....	13
6.2	ReportingFI.....	14
6.3	ReportingGroup	15
6.3.1	AccountReport.....	16
6.4	Shared structures.....	24
6.4.1	Name structures.....	24
6.4.2	Address structures.....	25
6.4.3	DocSpec structures	29
7	CHECKS MADE BY ILMOITIN.FI	31
8	MESSAGES FROM ILMOITIN.FI.....	35
9	FURTHER INFORMATION AND LINKS	38

VERSION HISTORY

Version	Date	Contents, notes
V 3.0	19 March 2024	<p>Updates made to:</p> <p>7 Check routines run by the Ilmoitin.fi service</p> <p>Text has been added about a situation where the file cannot be checked. The check routine was already included in Ilmoitin.fi, but now is has been added to the technical guidance</p>
V 2.9	28 August 2023	<p>Updates made to:</p> <p>1.1 Example files in the XML format</p> <p>Instructions for opening linked files were added</p> <p>5 Correction to previously filed returns</p> <p>Instructions were added for making corrections to ResCountryCode entries</p> <p>7 Checks made by Ilmoitin.fi</p> <p>The existing 'Individual/TIN/@IssuedBy' check process in Ilmoitin.fi was added to these Technical instructions</p>
V 2.8	28 March 2023	<p>Updates made to:</p> <p>5 Correction to previously filed returns</p> <p>8 Messages from Ilmoitin.fi</p>
V 2.7	30 March 2022	6.3.1.7 Payment
V 2.6	14 December 2021	<p>Updates made to:</p> <p>In the text boolean values earlier started with a capital letter. Values changed to true or false</p> <p>5 Correction to previously filed returns - text has been clarified</p> <p>7 Checks made by Ilmoitin.fi</p> <p>8. Messages from Ilmoitin.fi</p>
V 2.5	11 June 2021	<p>Updates made to:</p> <p>6.3.1 AccountReport; AccountTreatment and Self-Certification element</p> <p>6.4.2.1 AddressFix - Update to the instruction text</p> <p>7. Checks made by Ilmoitin.fi</p>

V 2.4	9 April 2021	Update to 2 The Ilmoitin.fi e-Service
V 2.3	30 March 2021	Update to 7. Checks made by Ilmoitin.fi - .../Address/AddressFix/City
V 2.2	13 January 2021	6.2 ReportingFI. Update to ReportingFI/IN issuedBy and INTType attributes.
V 2.1	17 December 2020	Section 1.1 XML example files. An example file related to deletion of individual account details was added. Section 5 Correction to previously filed returns. Deletion of individual account details was specified. Section 6.3.1 AccountReport. Data to be reported in the Self-Certification element was specified.
V 2.0	4 December 2020	Update to 2 The Ilmoitin.fi e-Service
V 1.9	10 November 2020	<p>The new version 1.9 and its changes will be implemented in Ilmoitin.fi starting 15 December 2020.</p> <p>Changes were made to the types of elements and attributes. Their minimum and maximum lengths were updated in order to match the CRS 2.0 reporting scheme. The impact of the update of minimum lengths is that the filers will no longer be able to leave an element blank because a required minimum must be reached.</p> <p>If the previous practice has involved the submittal of blank elements, this must be discontinued. After the update, filers should instead leave the entire element out of the reporting if no data for that element is on hand.</p> <p>The example below illustrates a post-office box element that can no longer be left blank. The element with no PO box has the following appearance:</p> <ul style="list-style-type: none"> • <taxfi:POB></taxfi:POB> <p>or alternatively:</p> <ul style="list-style-type: none"> • <taxfi:POB/> <p>A number of updates were made to:</p> <p>1 CRS and DAC2 – technical instructions (the XML example files are now in section 1.1)</p> <p>2 The Ilmoitin.fi e-Service (updated secure login)</p> <p>9 Further information and links: (files in XML were transferred to section 1.1, under "Example files in the XML format")</p>

V 1.8	19 October 2020	<p>Added information regarding non-disclosure for personal safety reasons:</p> <p>6.4.2 Address structures</p> <p>6.4.2.2 AddressFree</p> <p>Added new messages to:</p> <p>8. Messages from Ilmoitin.fi</p>
V 1.7	21 August 2020	<p>Correction to the Finnish version was made to 6.1 and 6.4.3 related to the CorrMessageRefId text. English version already had the correct text.</p>
V 1.6	9 June 2020	<p>A number of updates made to:</p> <p>7. Checks made by Ilmoitin.fi; and</p> <p>8. Messages from Ilmoitin.fi</p>
V1.5	17 Sept 2019	<p>Two new sections added:</p> <p>7. Checks made by Ilmoitin.fi; and</p> <p>8. Messages from Ilmoitin.fi</p> <p>The xml files that contain examples have some updates.</p>

1 CRS AND DAC2 RETURNS – TECHNICAL INSTRUCTIONS

The CRS and DAC2 return filing is for giving the Tax Administration details on the existence of reportable financial accounts as required by the provisions of Sections 17 b and c of Assessment Procedure Act (1558/1995) and the Tax Administration's official decision (no A35/200/2016) regarding annual information returns.

Separate "FATCA" return forms are in use for complying with the provisions of §17 a of Assessment Procedure Act concerning account holders in the U.S.A. and the FATCA rules. The information you have reported a FATCA return must not be repeated on the CRS and DAC2 filings discussed in this memorandum.

The technical instructions regarding the annual information return are based on the Common Reporting Standard guidance by the OECD and the AEOI DAC2 – Technical Specifications issued by the Commission of the European Union.

Filers must comply with the Tax Administration's guidance on how the provisions of Sections 17 b, c and d of Assessment Procedure Act must be applied on CRS and DAC2 reporting.

This memorandum supplements the existing reporting guidance. It gives Reporting Financial Institutions (= filers) further instructions for using the CRS and DAC2 filing scheme that the Tax Administration has published, discussing the application of the scheme from a technical perspective.

The CRS and DAC2 return consists of the following main structures, listed in the proper order below:

- MessageSpec, containing the annual return and the Reporting Financial Institution's (= filer's) name and contact details (identifying the financial institution concerned by the reporting requirement).
- ReportingFI, containing the reportable accounting data of the Reporting Financial Institution.
- ReportingGroup, with the AccountReport structure. The quantity of AccountReport structures may vary (from 0 to 'n'). Each AccountReport is expected to contain data on a reportable account and its holder.

This memorandum is enclosed with XML documents serving as examples, fulfilling the mandatory requirements set out by the Tax Administration.

This memorandum is to be applied from 17 December 2018 in all CRS and DAC2 returns.

1.1 Example files in the XML format

The links below point to a selection of XML files. They fulfill the Tax Administration's requirements of mandatory input. If any linked XML files fail to open, please first save this PDF file in your computer, and then use (Adobe Acrobat or another) PDF reader software to open the saved PDF. Now you can open the linked files in it.



1.2 How to read this memorandum

The document is primarily for people who are in charge of the production of CRS and DAC2 returns. Elements have an entry in their lower right-hand corner indicating how many times the element can be repeated: if it is "0...∞", it means up to 'n' times (or not at all). If it is "1...∞", it means the element may occur once or up to 'n' times (and occurs at least once).

Elements inside a solid frame are mandatory. A dotted line indicates elements to be included on a voluntary basis. However, although the scheme treats a number of elements as voluntary, some of them are mandatory. The checking process on www.ilmoitin.fi requires that they are included because it checks their data content.

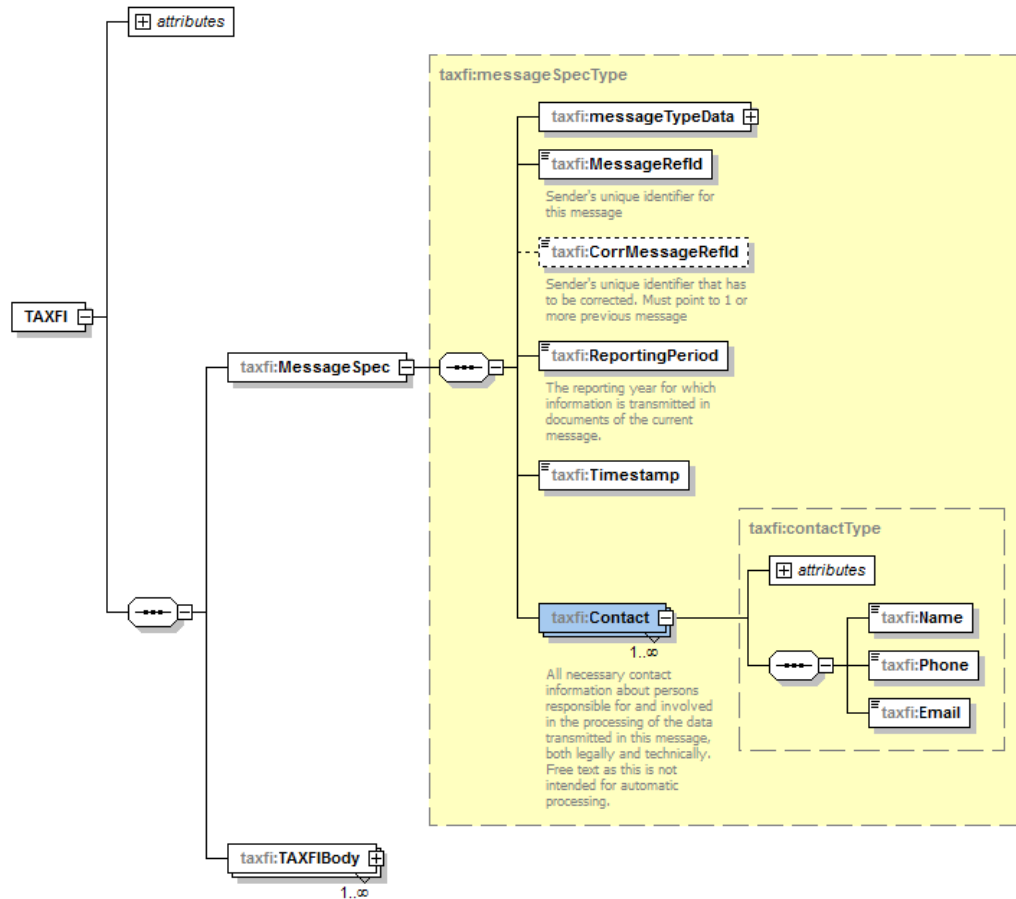

2 THE ILMOITIN.FI e-SERVICE

To e-file a CRS and DAC2 annual information return you must log on to www.ilmoitin.fi . User interfaces are available as a browser-based version and as a Web Services interface. You may either run the Ilmoitin.fi eService in a test environment on <https://testi.ilmoitin.fi> – or log on to its live version on www.ilmoitin.fi. Send e-mail to tamo.tk@vero.fi to ask for the addresses of the WebServices interfaces.

To upload records, you must log in to the service. Katso identification and Katso authorisations can no longer be used to log in to the Tax Administration's services after 31 August 2021. After that, only Suomi.fi authentication and Suomi.fi authorisations can be used. For more information on Suomi.fi authentication and authorisations, click on the links below:

- Suomi.fi authorisations: <https://www.suomi.fi/e-authorizations>
- More information about Suomi.fi authorisations: <https://www.suomi.fi/instructions-and-support/information-on-eauthorizations>
- How to grant a Suomi.fi authorisation for tax matters: <http://www.vero.fi/en/About-us/contact-us/efil/authorisations/>

Check the required method of sign-in and the required role [here](#).

At the moment filing a CRS/DAC2 annual return doesn't require additional Suomi.fi roles or rights. Suomi.fi e-identification is sufficient for submitting reports.

2.1 Technical requirements for the files to be submitted

Maximum file size is 100MB. If you create a file larger than 100MB in size, you must divide it into several smaller files that stay below the 100MB-limit. If you deliver such a file, consisting of several parts, each one of them must have a unique MessageRefId.

Encoding is UTF-8. For reasons of compatibility, you must use the ISO8859-1 character set where characters are encoded as per UTF-8. This also means that characters of the Cyrillic alphabet are not allowed. No Byte Order Mark (BOM) is allowed. Ilmoitin.fi runs a check to ensure that the character set is correct.

The following special characters must be converted into the following formats:

Character	Description	Required format
&	<i>ampersand</i>	<i>must be presented as &amp;</i>
<	<i>smaller than</i>	<i>must be presented as &lt;</i>
>	<i>greater than</i>	<i>must be presented as &gt;</i>
'	<i>apostrophe</i>	<i>must be presented as &apos;</i>
"	<i>quotation</i>	<i>must be presented as &quot;</i>

Table 1. Presentation of special characters in the data.

Additional requirements are shown below.

Char.	Description	Required format
--	<i>dash×2</i>	<i>Does not exist, must not be included in xml file</i>
/*	<i>slash,asterisk</i>	<i>Does not exist, must not be included in xml file</i>
&#	<i>ampersand, hash</i>	<i>Does not exist, must not be included in xml file</i>

Table 2. Additional restrictions and requirements.

3 FILING A RETURN

The deadline for reporting the CRS and DAC2 information for the previous calendar year is the end of January every year. One return cannot include information for more than one Financial Institution.

All the required CRS and DAC2 details can be filed on one single return.

4 FILING A "NIL" RETURN

If you have no reportable CRS and DAC2 details (in reference to the provisions of 17 b or c, Assessment Procedure Act), it is enough if you just file a nil return for that year.

Complete the annual information specifics, the Reporting Financial Institution's name and contact details in the MessageSpec structure and enter "CRS703" as the value of the MessageTypeIndic element.

Also complete the ReportingFI structure regarding the identity information of the filer.

If you are filing a nil return, ilmoitin.fi runs a check making sure that no AccountReport structures are included. An example of a "nil" return is provided among the XML example files, the Nollailmoitus_2020.xml file – section 1.1 above.

5 CORRECTION TO PREVIOUSLY FILED RETURNS

Up to 31 July, you can still make corrections to an annual information return by filing a replacement, which is treated as a full replacement of the original one. Replacement returns must have 'OECD1' as the value of the DocTypeIndic element. The MessageRefId must be exactly the same as that of the original annual information return. If the only correction is that the filer adds some more reportable financial accounts, another option besides replacement is to submit a separate new return. Such a new return must have a different MessageRefId, and as a result, it does not replace the original. Instead, the new return is a complement to the year's reporting. The filer bears responsibility for making sure that all the reportable financial accounts are included in the year's reporting.

It is possible for the replacement return to be a "nil" return. It may be that an original return cannot be replaced by a nil return. If this is the case, and you want to remove your previous return because it was unnecessary to submit it, and it is not yet possible to make corrections on a correction return, please send e-mail to fatca@vero.fi at the Tax Administration.

Replacement filings are no longer accepted when the deadline has passed. Instead, you must follow the procedure of corrections described below, and corrections will be accepted starting 1 September.

The principle of making corrections is to send us corrected information separately for the specific structural parts. Each "independent" structure (ReportingFI, AccountReport) has its own DocRefId and DocTypeIndic; they also have specific CorrDocRefId and CorrMessageRefId that allow corrections to be entered. When you submit corrections, they must be related to just one previous filing. This means that the CorrMessageRefId must be the same for all the structures you submit.

Rules on DocTypeIndic values when submitting corrections:

- OECD0: Only for ReportingFI structures in situations where the filer's identity details are not changed.
- OECD1: To be used whenever new data is being reported, i.e. data that have previously not been reported or that had previously been deleted
- OECD2: To be used whenever previously submitted data is being corrected
- OECD3: To be used whenever previously submitted data is being deleted

A correction return may not contain both new data (DocTypeIndic=OECD1) and corrections (OECD2) and deletions (OECD3). A correction return may contain only AccountReport elements that have the same DocTypeIndic value.

For example, if you only want to remove individual AccountReport structures, enter the value OECD0 in the DocTypeIndic element of the ReportingFI structure (and do not report CorrDocRefId and CorrMessageRefId for this structure), and enter OECD3 in the DocTypeIndic element of the AccountReport structures that are to be removed.

DocTypeIndic of ReportingFI structure can have value OECD2 only if you have identified an error in the ReportingFI structure which you need to correct. The only situation where you can remove the ReportingFI (using OECD3) is that you want to remove the entire previously submitted return.

If you need to replace a ResCountryCode entry of account holders or controlling persons (for example, your previous filing contained SE as someone's ResCountryCode but it should be DE), you need to submit a deletion first (OECD3) in

order to remove the previous filing's entry. After the original is deleted, you can submit a new return that contains the country code as it should be (OECD1).

If you need to add a ResCountryCode entry concerning an account holder or controlling person because it is missing (for example, your previous filing contained SE as someone's ResCountryCode but DE should also be included), you need to submit a deletion first (OECD3) in order to remove the previous filing's entry. After the original is deleted, you can submit a new return that contains all the country codes as they should be (OECD1).

If you want to file a replacement after 31 August to remove a previous return completely, as it had been unnecessary, you must delete all the structures by setting "OECD3" as the DocTypeIndic value. This will remove the information from the recipient countries (for more information, see the example files in XML, above in 1.1).

If you want to add new reportable financial accounts that your previously submitted return did not contain (DocTypeIndic=OECD1), please contact the Tax Administration to set a suitable date for sending the return, because Ilmoitin.fi no longer automatically accepts filings with the OECD1 value when 31 July has passed.

6 STRUCTURE OF THE XML SCHEME

This section describes the elements of scheme, presenting them specifically and also discussing the check runs by Ilmoitin.fi that are external to the xml scheme.

The namespace of the scheme is "taxfi". This is not for presenting the namespace globally; instead, it is intended to be used together with element names.

6.1 MessageSpec

MessageSpec contains information identifying the annual return and the filer, including filer's name and contact details (identifying the financial institution concerned by the reporting requirement) in matters having to do with CRS and DAC2.

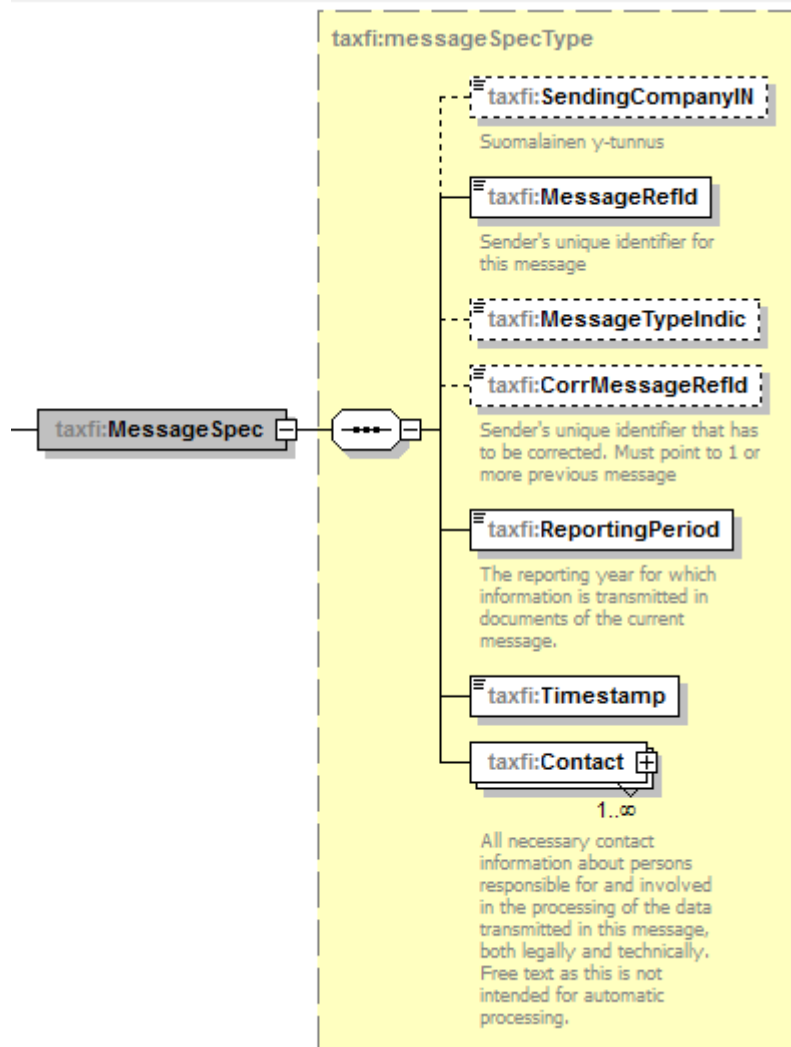

Element	Attribute	Size	Input Type	Requirement	Validated
SendingCompanyIN		1-200 characters	taxfi:StringMin1Max 200 Type	Mandatory	Yes

- Filer's Finnish Business ID
 - o Filer means ReportingFI
- Format of Business ID is automatically checked by ilmoitin.fi
- If the filer has no Finnish Business ID, you must contact the Tax Administration

Element	Attribute	Size	Input Type	Requirement	Validated
MessageRefId		Max 170 characters	taxfi:messageRefId_Type	Mandatory	Yes

- The unique Identifying Number created by the filer.
- It is the filer's responsibility to make sure that no returns are filed under the same MessageRefId as a previously filed CRS/DAC2 or FATCA return
 - o However, if a replacement return is submitted, it is expected to have the same MessageRefId as the original
- Required information: The Finnish Business ID of the filer, the reporting year, and a sequential number (Note: cannot be the same as the number on the FATCA return), as in:
 - o Originally filed return: 6606611-7-2018-1
 - o Replacement: 6606611-7-2016-1
 - o Return filed later with corrections: 6606611-7-2018-2
- The check process of the ilmoitin.fi eService looks into the format of the Finnish Business ID, the year, and the sequential number.

Element	Attribute	Size	Input Type	Requirement	Validated
---------	-----------	------	------------	-------------	-----------

MessageTypeIndic		6 characters	taxfi:messageTypeIndic_EnumType	Mandatory	
------------------	--	--------------	---------------------------------	-----------	--

- Indicates the type of the return being filed:
 - o CRS701: Contains new information. This value is also used when filing a replacement.
 - o CRS702: Contains corrections for previously sent information.
 - o CRS703: Nil return, advising that there's no data to report. Use when reporting the information that there are no accounts subject to reporting (no CRS and DAC2 details to report). If you are filing a nil return, the www. ilmoitin.fi runs a check making sure that no AccountReport structures are included.

Element	Attribute	Size	Input Type	Requirement	Validated
CorrMessageRefId		1-170 characters	taxfi:StringMin1Max170 Type	Optional	Yes

- This is the MessageRefId of the return being corrected.
- Use the CorrMessageRefId element with correction filings only.
- Example: 6606611-7-2018-1
- The check process of ilmoitin.fi looks into the format of the Finnish Business ID, the year, and the sequential number.
- The correction filing must make reference to just one previous filing (to just one MessageRefId)

Element	Attribute	Size	Input Type	Requirement	Validated
ReportingPeriod		10 characters	xs:date	Mandatory	Yes

- The calendar year of reporting
- Format YYYY-12-31 denoting the last date of the calendar year: for 2018 the element should be: 2018-12-31
- It is the responsibility of the filer to make sure that the return is filed under the right scheme for the right year
- Corrections continue to be accepted during a period of 1+5 years.

Element	Attribute	Size	Input Type	Requirement	Validated
Timestamp		20 characters	xs:dateTime	Mandatory	Yes

- Time stamp for saving the return file. Example: 2019-02-17T09:30:45Z
- The sender must add this element
- Note: When filing a replacement, its time stamp must indicate a later date/time than that of the original.

Element	Attribute	Size	Input Type	Requirement	Validated
Contact			taxfi:contactType	Mandatory	

- [Learn more on the contents of the Contact structure in section 6.1.1 Contact](#)

6.1.1 Contact

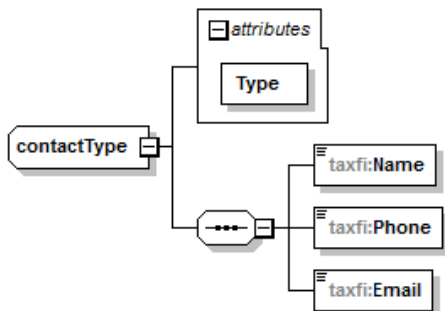

Element	Attribute	Size	Input Type	Requirement	Validated
	Type	Listed values	taxfi:contactType_Type	Mandatory	
Name		1-200 characters	taxfi:contactName_Type	Mandatory	
Phone		6-16 characters	taxfi:phoneType	Mandatory	
Email		Max 254 characters	taxfi:emailType	Mandatory	

- The last name and first name of the person to contact, plus their international phone number and e-mail. This information is not disclosed outside the Tax Administration.
- You must provide at least one contact.
- The Type attribute indicates the contact person's type. Values may be:
 - o technical = person to contact in technical matters such as the structure of the message, problems in establishing contact
 - o administrative = person to contact in matters relating to the subject matter

6.2 ReportingFI

This element contains the reportable accounting data of the reporting financial institution concerned.

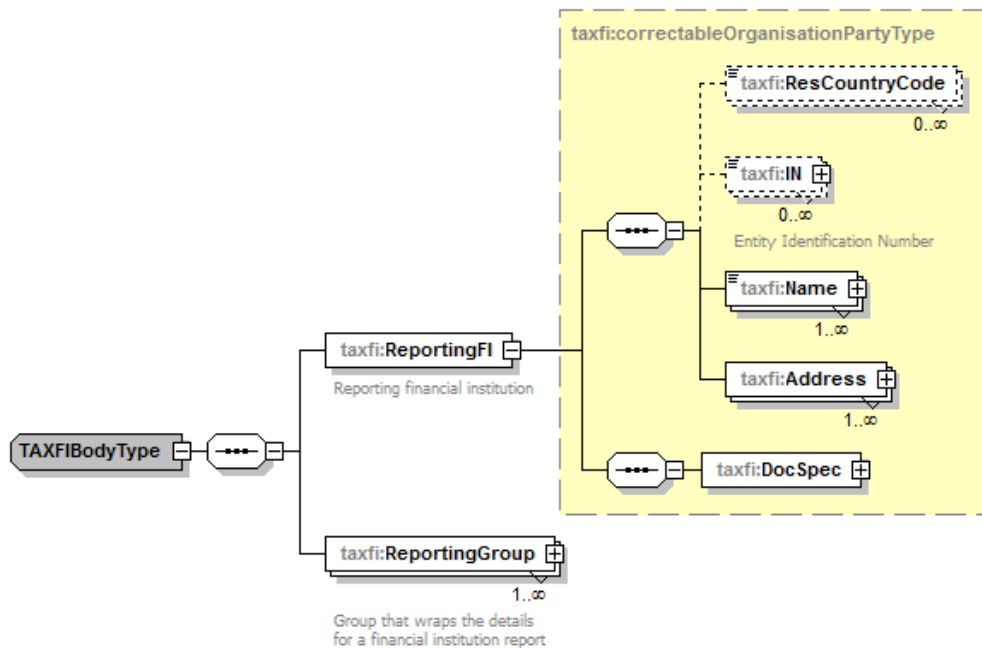

Element	Attribute	Size	Input Type	Requirement	Validated
ResCountryCode		2 characters	xs:string	Mandatory	Yes

- Filer's country of domicile. For financial institutions in Finland, the value is "FI".
- The 2-letter code denoting the country (Country Code) (ISO-3166 Alpha 2)

Element	Attribute	Size	Input Type	Requirement	Validated
IN		1-200 characters	taxfi:organisationINType	Mandatory	Yes
	issuedBy	2 characters	iso:CountryCode Type	Mandatory	Yes
	INType	1-200 characters	taxfi:StringMin1Max200_Type	Mandatory	Yes

The IN of the filer:

- This is a mandatory element also for nil-return filings
- The selection is the GIIN if the filer has one. If there is no GIIN, give the Finnish Business ID. If the filer has no GIIN and no Finnish Business ID, you must contact the Tax Administration.

Attribute issuedBy:

- Country of issue of the IN, either "US" or "FI"
- Country code, 2 letters

Attribute INType:

- The type of the IN indicates its type. Permissible values:
 - US GIIN
 - TIN (when a Business ID is being used)

Element	Attribute	Size	Input Type	Requirement	Validated
Name		1-200 characters	taxfi:nameOrganisationType	Mandatory	Yes

- Filer's registered business name.

Element	Attribute	Size	Input Type	Requirement	Validated
Address			taxfi:addressType		

- For more information on Address structures, see [6.4.2 Address structures](#)

Element	Attribute	Size	Input Type	Requirement	Validated
DocSpec			taxfi:docSpecType		

- For more information on DocSpec structures, see [6.4.3. DocSpec structures](#)

6.3 ReportingGroup

The accounting data, subject to reporting, of the financial institution concerned.



6.3.1 AccountReport

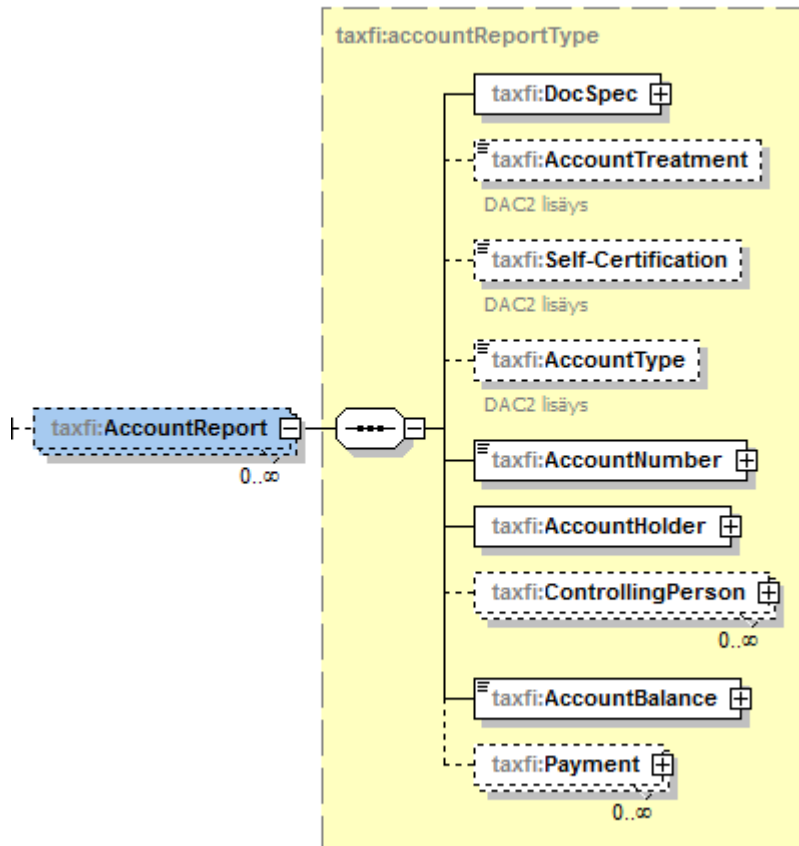

This structure is for account holder, account, and balance.

Element	Attribute	Size	Input Type	Requirement	Validated
DocSpec			taxfi:docSpecType		

- For more information on DocSpec structures, see [6.4.3. DocSpec structures](#)

Element	Attribute	Size	Input Type	Requirement	Validated
AccountTreatment		Listed values	taxfi:accountTreatment EnumType	Optional	

- State whether the reportable account is New or Pre-existing.
- This element is always mandatory for new accounts
- Mandatory for pre-existing accounts, if the Financial Institution's data system contains the information
- Permissible values:
 - o CRS981: Pre-existing Account
 - o CRS982: New Account

Element	Attribute	Size	Input Type	Requirement	Validated
Self-Certification		Listed values	taxfi:self-Certification EnumType	Optional	

- State whether the Financial Institution has received reliable self-certification from the account holder regarding the place (places) of tax residence
- This element is always mandatory for new accounts
- Mandatory for pre-existing accounts, if the Financial Institution's data system contains the information
- Permissible values:

- CRS971: No self-certification has been received (used only if the account holder has not provided any reliable self-certification at all)
- CRS972: The account holder has provided a self-certification.

Element	Attribute	Size	Input Type	Requirement	Validated
AccountType		Listed values	taxfi:accountType_EnumType	Optional	

- This element indicates the type of the reportable account
 - CRS991: Depository Account
 - CRS992: Custodial Account
 - CRS993: Debt or Equity in Investment Entity
 - CRS994: Cash Value Insurance or Annuity Contract
- A mandatory element if the Financial Institution’s data system contains the information.

6.3.1.1 AccountNumber

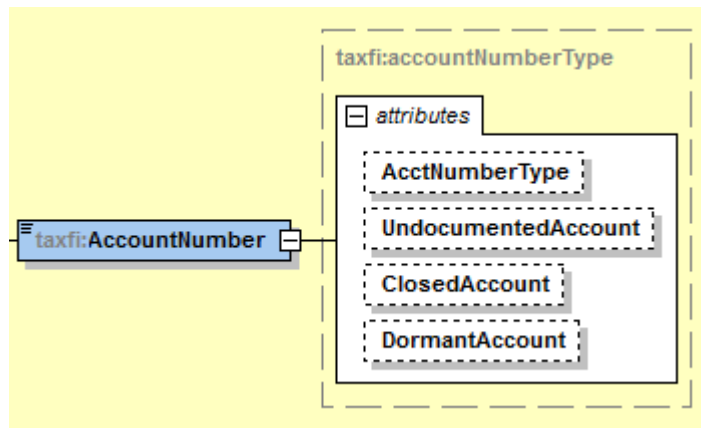

Element	Attribute	Size	Input Type	Requirement	Validated
AccountNumber		2-200 characters	taxfi:accountNumberType	Mandatory	Yes
	AcctNumberType	2-200 characters	taxfi:acctNumberType EnumType	Optional	
	UndocumentedAccount		xs:boolean	Optional	
	ClosedAccount		xs:boolean	Optional	
	DormantAccount		xs:boolean	Optional	

- Account holder's account number
 - Ilmoitin runs a check for formal correctness when the type of the bank account number is IBAN (OECD601) or ISIN (OECD603).
 - Ilmoitin also validates the IBAN (OECD601) check digits.
- If no conventional account number is available, you must give the Customer Code that the filer uses for business purposes in order to specify the account holder's assets
 - Examples: insurance contract no, agreement no, accounts payable no, verbal description of the account or any similar identifier
- The following specific attributes are used:
 - Type (AccountNumberType)
 - OECD601 IBAN International Bank Account Number
 - OECD602 OBAN Other Bank Account Number
 - OECD603 ISIN International Securities Information Number
 - OECD604 OSIN Other Securities Information Number
 - OECD605 Other account number type e.g. an identifier of an insurance contract
 - Undocumented account (UndocumentedAccount)
 - it should be indicated whether the reportable account is undocumented (true) or not (false)
 - a mandatory element if there's no documentation on the account
 - Closed account (ClosedAccount)

- it should be indicated whether the reportable account is closed or transferred away (true) or not (false) during the calendar year
- in case it is closed, Ilmoitin runs a check to make sure its balance is 0.00 (zero) (AccountBalance)
- Dormant account (DormantAccount)
 - it should be indicated whether the reportable account is dormant (true) or not (false)
 - a mandatory element in cases where the Residence Address Test has identified the account holder as a Reportable party, and identification was based on the dormant-account method.

6.3.1.2 AccountHolder structures/Individual

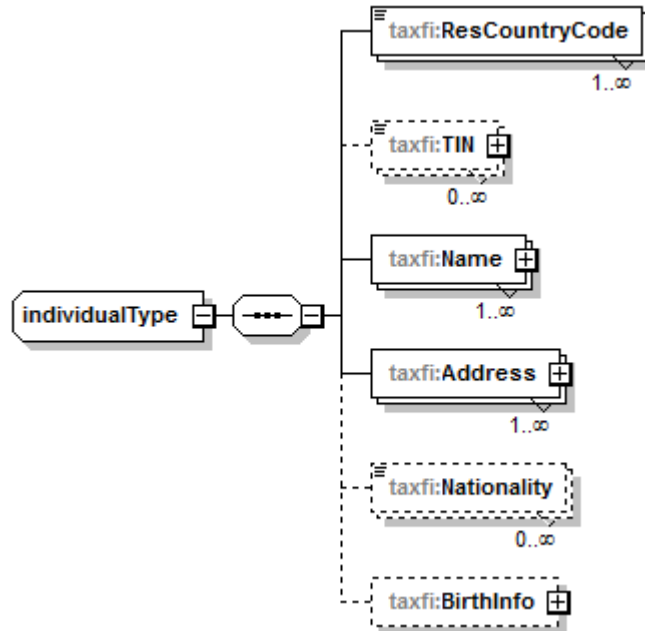

Element	Attribute	Size	Input Type	Requirement	Validated
ResCountryCode		2 characters	iso:CountryCode_Type	Mandatory	Yes

- This element is mandatory
 - The 2-letter code denoting the country (Country Code) (ISO-3166 Alpha 2)
- Country of tax residence of a reportable individual (Account holder / Controlling person)
- In the case of Pre-Existing Account, if the country of tax residence of the account holder is not known, enter the ResCountryCode of that country for which an indicium is identified
- If the individual is a resident of more than one country, you must list all of them
- If the account is Undocumented, and due to this, their country of residence is not known, or if the account holder is identified as (a tax nomad) one who does not have a country of tax residence, enter "FI"
- If the account holder's Country issuing the TIN is not on the List of Country Codes, please contact the Tax Administration to agree on how this account holder's information should be reported.

Element	Attribute	Size	Input Type	Requirement	Validated
TIN		1-200 characters	taxfi:tinType	Mandatory	

- Account holder's / Controlling person's TIN in their country of residence
 - This element is always mandatory for new accounts
 - For older accounts, this element is mandatory if the filer is aware of the TIN of the account holder or controlling person
- If the individual is a resident of more than one country, you must give the TINs for each one of them

- If the TIN issued by the country of residence is not known to the filer, use their Finnish personal identity code
- If no TIN or Finnish personal identity code is available, use their other identity code (TIN) issued by a foreign country for tax purposes
- If Reporting Financial Institution does not have any TIN available for the account holder or controlling person, enter nine zeroes "000000000".
- Ilmoitin.fi runs a check on the format of the TIN when it comes from an EU country.
- Ilmoitin.fi runs a check on the entry: this data element is mandatory. If it is missing, the return cannot be submitted.

Element	Attribute	Size	Input Type	Requirement	Validated
TIN	issuedBy	2 characters	iso:CountryCode_Type	Optional	Yes

- Country (countries) of issue of the TIN (or TINs)
- This is a mandatory data element if a TIN is included
 - o If the TIN element is padded with 9 zeroes, you must leave this attribute blank
- The 2-letter code denoting the country (Country Code) (ISO-3166 Alpha 2)
- If the account holder's Country issuing the TIN is not on the List of Country Codes, please contact the Tax Administration to agree on how this account holder's information should be reported.

Element	Attribute	Size	Input Type	Requirement	Validated
Name			taxfi:namePersonType		

- For more information on Name structures, see 6.4.1 Name structures

Element	Attribute	Size	Input Type	Requirement	Validated
Address			taxfi:addressType		

- For more information on Address structures, see 6.4.2 Address structures

Element	Attribute	Size	Input Type	Requirement	Validated
Nationality		2 characters	iso:CountryCode_Type	Optional	Yes

- Not used

6.3.1.2.1 BirthInfo

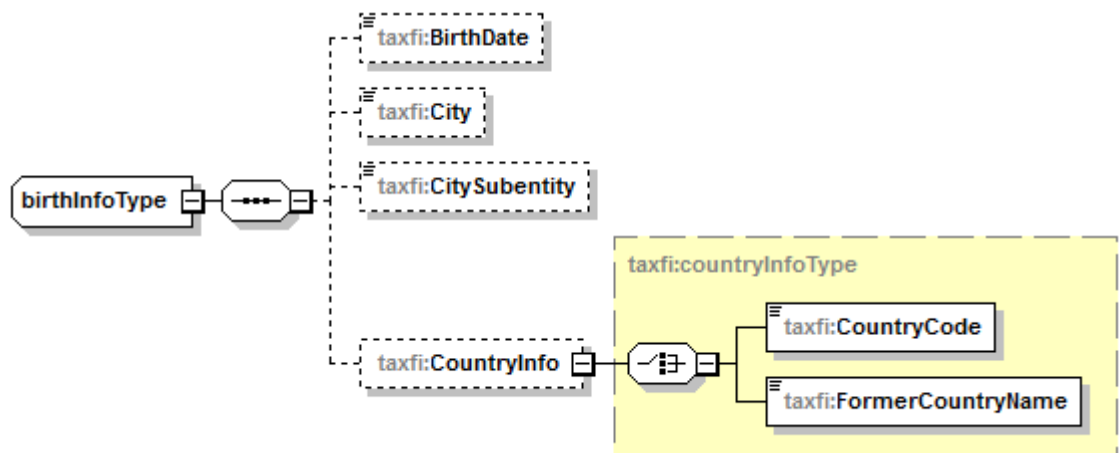

The BirthInfo structure and its content details must always be included.

Element	Attribute	Size	Input Type	Requirement	Validated
BirthDate		10 characters	xs:date	Optional	

- Account holder's date of birth
- This element is mandatory if the date is known to the filer
- Required format for the date is YYYY-MM-DD. Example: 1975-01-21

Element	Attribute	Size	Input Type	Requirement	Validated
City		1-200 characters	taxfi:StringMin1Max200_Type	Optional	

- Account holder's place of birth
- This element is mandatory if the place is known to the filer

Element	Attribute	Size	Input Type	Requirement	Validated
CitySubentity		1-200 characters	taxfi:StringMin1Max200_Type	Optional	

- Account holder's district of birth, such as a sub-entity of a city
- This element is mandatory if the place is known to the filer

Element	Attribute	Size	Input Type	Requirement	Validated
CountryCode		2 characters	iso:CountryCode_Type	Optional	

- Country of birth
- This element is mandatory if the country is known to the filer

Element	Attribute	Size	Input Type	Requirement	Validated
FormerCountryName		1-200 characters	taxfi:StringMin1Max200_Type	Optional	

- The former name of the country of birth
- This element is mandatory if the former country name is known to the filer

6.3.1.3 AccountHolder structures/Organisation

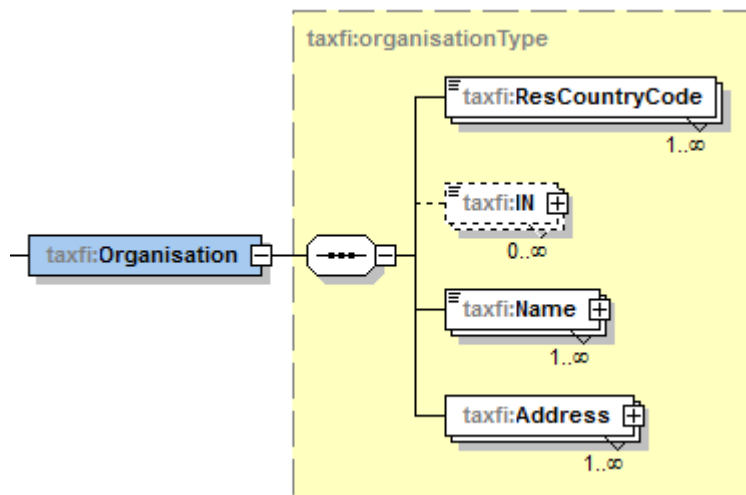

Element	Attribute	Size	Input Type	Requirement	Validated
ResCountryCode		2 characters	iso:CountryCode_Type	Mandatory	Yes

- The entity's country of tax residence
- The 2-letter code denoting the country (Country Code) (ISO-3166 Alpha 2)
- This element is mandatory
- If the filer is in doubt, and the information is controversial on the entity's country of residence, you must list all the countries involved.
 - o Example: An entity is registered as a limited company in country 'X'. However, its addresses and contacts are always in country 'Y', and no reliable information on the country of tax residence has been received
- If the account holder's Country issuing the TIN is not on the List of Country Codes, please contact the Tax Administration to agree on how this account holder's information should be reported.

Element	Attribute	Size	Input Type	Requirement	Validated
IN		1-200 characters	taxfi:organisationINType	Mandatory	

- Account holder's tax identification number (s) (IN) in the country (countries) of residence
 - o This element is always mandatory for new accounts
 - o For older accounts, this element is mandatory if the filer is aware of the TIN of the account holder
- If the account holder is resident in more than one countries, you must list all the tax identification numbers for all the countries involved
- If Reporting Financial Institution does not have any TIN available for the account holder or controlling person, enter nine zeroes "000000000".
- Ilmoitin.fi runs a check on the IN entry: this data element is mandatory. If it is missing, the return cannot be submitted.

Element	Attribute	Size	Input Type	Requirement	Validated
IN	issuedBy	2 characters	iso:CountryCode_Type	Optional	Yes

- Country (or countries) issuing the identification number (the IN)
- This is a mandatory data element if an IN is included
- If the IN element is padded with 9 zeroes, you must leave this attribute blank
- The 2-letter code denoting the country (Country Code) (ISO-3166 Alpha 2).
 - o If the account holder's Country issuing the TIN is not on the List of Country Codes, please contact the Tax Administration to agree on how this account holder's information should be reported.

Element	Attribute	Size	Input Type	Requirement	Validated
IN	INType	1-200 characters	taxfi:StringMin1Max200_Type	Optional	

- The INType attribute indicates the type of the tax identification number. Commonly used types include:
 - o TIN
 - o US GIIN
 - o EIN
 - o LEI
- This is a mandatory data element if the type of the IN is known to the filer.

Element	Attribute	Size	Input Type	Requirement	Validated
Name		1-200 characters	taxfi:nameOrganisationType	Mandatory	Yes

- Account holder's registered business name

Element	Attribute	Size	Input Type	Requirement	Validated
Address			taxfi:addressType	Mandatory	Yes

- For more information on Address structures, see 6.4.2 Address structures

6.3.1.4 AccountHolder structures/AcctHolderType

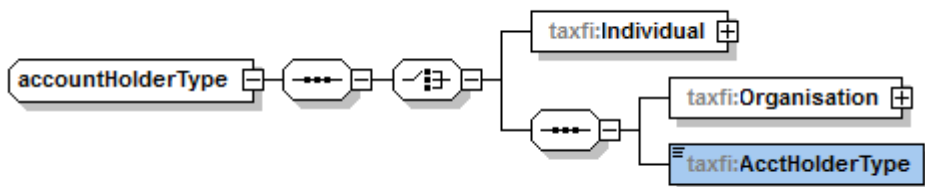

Element	Attribute	Size	Input Type	Requirement	Validated
AcctHolderType		Listed values	taxfi:acctHolderType_EnumType	Mandatory	

- The account holder's type
 - o CRS101 Passive Non-Financial Entity with one or more controlling person that is a Reportable Person) (regardless of whether the entity itself is a Reportable Person)
 - o CRS102 Reportable Person
 - o CRS103 Passive Non-Financial Entity that is a Reportable Person

- This is a mandatory data element if the account holder is not an individual (the account is an entity account)
- If the account holder has a controlling person that is a Reportable Person, you must invariably use CRS101
 - o Ilmoitin runs a check to make sure that the account holder has at least one controlling person (ControllingPerson structure)
- If the account holder is an active Non-Financial Entity, you must use CRS102
 - o Ilmoitin runs a check to make sure the account holder has not reported a controlling person (ControllingPerson structure)
- Always use CRS103 if the account holder is a passive Non-Financial Entity residing in a reportable country (not Finland) regardless of whether they have Reportable Controlling Persons or not,
 - o If a passive Non-Financial Entity residing in a reportable country has one or more people who are Reportable Controlling Persons, you also have to submit CRS101, the type of account holder, in addition to CRS103.
 - o This means that in this case, you must report the account both as CRS101 and also as CRS103.
 - o If the account holder is a Finnish-resident passive Non-Financial Entity and it has Reportable Controlling Persons, you must use CRS101 only.

6.3.1.5 ControllingPerson

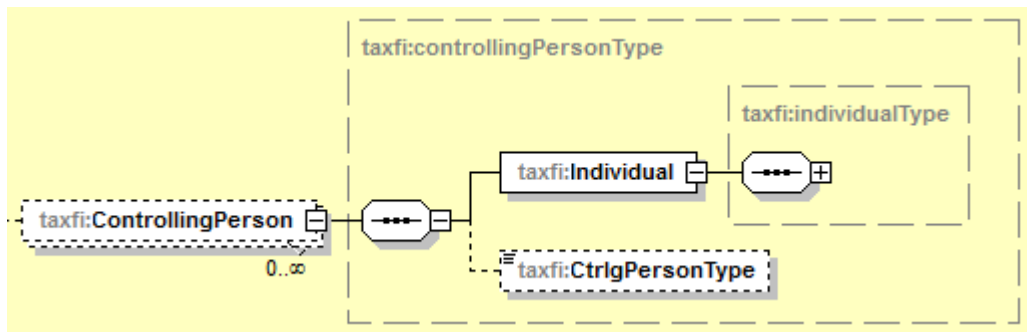

- The data elements are the same as those of AccountHolder/Individual. For information on this structure, see 6.3.1.2 AccountHolder structures/Individual
- This data element is mandatory only if it is known to the financial institution that there are Controlling Persons who are Reportable as regards the account (in other words, controlling persons with another country than Finland as the country of residence, as evidenced either by self-certification or by indicia).
- Information must be included in the ControllingPerson structure only when an account holder is being reported, having an AcctHolderType = CRS101 i.e. "the account holder is a passive Non-Financial Entity and it has one, or more than one, Reportable Controlling Persons".
- For every "CRS101 account" being reported, you must include all the individuals whom you have identified as Reportable Controlling Persons give complete details on gross assets and all transactions for each.
- If the account holder is a passive Non-Financial Entity that has no Controlling Persons with country of residence other than Finland, do not use code CRS101 to report this account holder, and consequently, do not report any controlling persons.
- If the passive Non-Financial Entity that you reported under code CRS101 also is a Reportable Person (in other words, the Entity's country of residence is other than Finland), you must additionally use code CRS103 to report this account holder specifically in these circumstances, you must report this account both under CRS101 and under CRS103.
- The information on controlling persons must contain the CtrlgPersonType element
- You must use the classification in the next element in order to give details on how the Controlling Person has control over the unit

Element	Attribute	Size	Input Type	Requirement Yes/No	Validated
CtrlgPersonType		Listed values	taxfi:controllingPerson-Type EnumType	Optional	

- This element is mandatory if a Controlling Person is being reported
- This indicates the status of the Controlling Person
- CRS801 = CP of legal person – ownership
- CRS802 = CP of legal person – other means
- CRS803 = CP of legal person – senior managing official
- CRS804 = CP of legal arrangement – trust – settlor
- CRS805 = CP of legal arrangement – trust – trustee
- CRS806 = CP of legal arrangement – trust – protector
- CRS807 = CP of legal arrangement – trust – beneficiary
- CRS808 = CP of legal arrangement – trust – other
- CRS809 = CP of legal arrangement – other – settlor-equivalent
- CRS810 = CP of legal arrangement – other – trustee-equivalent
- CRS811 = CP of legal arrangement – other – protector-equivalent
- CRS812 = CP of legal arrangement – other – beneficiary-equivalent
- CRS813 = CP of legal arrangement – other – other-equivalent
- (CRS819 - Not used)

6.3.1.6 AccountBalance

Element	Attribute	Size	Input Type	Requirement	Validated
AccountBalance		1-24 characters	taxfi:accountBalanceType	Mandatory	Yes
	currCode	3 characters	iso:currCode Type	Mandatory	Yes

- Balance of the account
 - o In the case of a closed account (AccountNumber/ClosedAccount="true"), Ilmoitin runs a check to make sure its balance is 0.00 (zero)
- Give the balance at end of calendar year
- Use the currency actually used
- If balance is 0 or negative, enter 0.00.
- Ilmoitin.fi blocks negative values
- Always enter the amount with two decimals, separator is the "." character.
Example: enter 1000.00 for one thousand euros
- The currCode attribute is for indicating the currency being used

6.3.1.7 Payment

Element	Attribute	Size	Input Type	Requirement	Validated
Type		Listed values	taxfi:paymentType_EnumType	Optional (Mandatory)	

- Category of the income
 - o CRS501 = Dividends
 - o CRS502 = Interest
 - o CRS503 = Gross proceeds/redemptions
 - o CRS504 = Other
- When reporting payments with respect to an Equity Interest or a Debt Interest, a Cash Value Insurance Contract or an Annuity Contract, either give a lump sum (CRS504) or specify all income types involved (CRS501-CRS503)

Element	Attribute	Size	Input Type	Requirement	Validated
PaymentAmnt		1-24 characters	taxfi:paymentAmntType	Mandatory	Yes
	currCode	3 characters	iso:currCode Type	Mandatory	Yes

- Amount paid to the account
- Always enter the amount with two decimals, separator is the "." character.
Example: enter 1000.00 for one thousand euros
- The currCode attribute is for indicating the currency

6.4 Shared structures

This section discusses the structures that are shared by the different parts of the scheme. Reference to them is made wherever shared structures are used.

6.4.1 Name structures

Element	Attribute	Size	Input Type	Requirement	Validated
PrecedingTitle		1-200 characters	taxfi:StringMin1Max200_Type	Optional	

- Not used

Element	Attribute	Size	Input Type	Requirement	Validated
Title		1-200 characters	taxfi:StringMin1Max200_Type	Optional	

- Not used

Element	Attribute	Size	Input Type	Requirement	Validated
FirstName		1-200 characters	taxfi:firstNameType	Mandatory	

- Account holder's / Controlling person's first name
- If the first name is not available, enter "NFN" (No First Name)

Element	Attribute	Size	Input Type	Requirement	Validated
MiddleName		1-200 characters	taxfi:middleNameType	Optional	

- Account holder's / Controlling person's middle name or names

Element	Attribute	Size	Input Type	Requirement	Validated
NamePrefix		1-200 characters	taxfi:namePrefixType	Optional	

- Account holder's / Controlling person's last name may have a "prefix" such as van, von, de, von de, etc.
- Alternatively, include the prefix in the LastName element

Element	Attribute	Size	Input Type	Requirement	Validated
LastName		1-200 characters	taxfi:lastNameType	Mandatory	

- Account holder's / Controlling person's last name
- Include all the last names of a natural person in this field
- In situations where the filer does not know the account holder's first name, or does not know which one of the account holder's names is/are first name(s), all names can be entered in the LastName element and "NFN" (No First Name) is entered in the FirstName element.

Element	Attribute	Size	Input Type	Requirement	Validated
GenerationIdentifier		1-200 characters	taxfi:StringMin1Max200_Type	Optional	

- Not used

Element	Attribute	Size	Input Type	Requirement	Validated
Suffix		1-200 characters	taxfi:StringMin1Max200_Type	Optional	

- Not used

Element	Attribute	Size	Input Type	Requirement	Validated
GeneralSuffix		1-200 characters	taxfi:StringMin1Max200_Type	Optional	

- Not used

6.4.2 Address structures

Because the Address is a mandatory element, either the AddressFix structure or the AddressFree structure must contain it. You must utilize the AddressFix fields when creating your filing if the input information is available to you.

In case an individual Account Holder or a Controlling Person of a Passive Non-Financial Entity has been recorded a non-disclosure for personal safety reasons in the Population Information System, either in Finland or in some other jurisdiction, address information that is under such non-disclosure should not be reported; instead some other address, which is public and safe for the customer in question, should be reported. In Finland such safe address is a public contact address recorded in the Population Information System. Contact address can be for example a PO Box address either in the municipality of residence of the customer or in some other municipality. You can find further guidance in section 6.4.2.2.

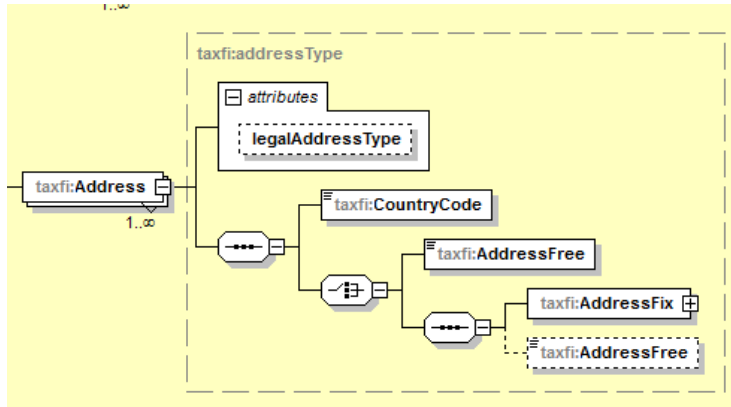

Element	Attribute	Size	Input Type	Requirement	Validated
Address	legalAddressType	Listed values	taxfi:OECDLegalAddressType EnumType	Optional	

- Type of address:
 - o OECD301= residential or business
 - o OECD302= residential
 - o OECD303= business
 - o OECD304= registered office
 - o OECD305= unspecified

Element	Attribute	Size	Input Type	Requirement	Validated
CountryCode		2 characters	iso:CountryCode Type	Mandatory	

- Country of location relating to the address
- The 2-letter code denoting the country (Country Code) (ISO-3166 Alpha 2)

6.4.2.1 AddressFix

If you are using AddressFix to facilitate address reporting, you must enter at least the following details in this structure, if they are available:

- City
- Postal code
- State or other Country Subentity

In addition, the full street address must be reported in the relevant elements, but it is also allowed to enter the street address in AddressFree structure, while above listed details are entered in AddressFix structure. Please see more details in 6.4.2.2 AddressFree

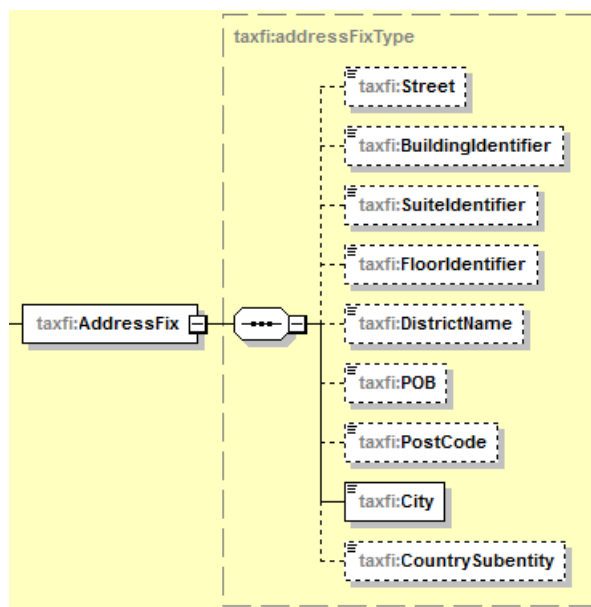

Element	Attribute	Size	Input Type	Requirement	Validated
Street		1-200 characters	taxfi:StringMin1Max200_Type	Optional	

- Street name
- This element is mandatory if the street is known to the filer

Element	Attribute	Size	Input Type	Requirement	Validated
BuildingIdentifier		1-200 characters	taxfi:StringMin1Max200_Type	Optional	

- House number or building number
- This element is mandatory if the value is known to the filer

Element	Attribute	Size	Input Type	Requirement	Validated
SuiteIdentifier		1-200 characters	taxfi:StringMin1Max200_Type	Optional	

- Number denoting the Unit/Apartment/Suite
- This element is mandatory if the value is known to the filer

Element	Attribute	Size	Input Type	Requirement	Validated
FloorIdentifier		1-200 characters	taxfi:StringMin1Max200_Type	Optional	

- Floor where the dwelling or office is located
- This element is mandatory if the value is known to the filer

Element	Attribute	Size	Input Type	Requirement	Validated
DistrictName		1-200 characters	taxfi:StringMin1Max200_Type	Optional	

- Section, neighbourhood or district of the city
- This element is mandatory if the value is known to the filer

Element	Attribute	Size	Input Type	Requirement	Validated
POB		1-200 characters	taxfi:StringMin1Max200_Type	Optional	

- Post office box number
- This is a mandatory data element for all addresses that have a P.O. Box.

Element	Attribute	Size	Input Type	Requirement	Validated
PostCode		1-200 characters	taxfi:StringMin1Max200_Type	Optional	

- Postal code
- This element is mandatory if the value is known to the filer

Element	Attribute	Size	Input Type	Requirement	Validated
City		2-200 characters	taxfi:cityType	Mandatory	Yes

- City, Town or Municipality
- This element is mandatory

Element	Attribute	Size	Input Type	Requirement	Validated
CountrySubentity		1-200 characters	taxfi:StringMin1Max200_Type	Optional	

- State, Province, or other sub-entity relating to the Country
- This element is mandatory if the value is known to the filer

6.4.2.2 AddressFree

This structure must be used if the address cannot be entered in the AddressFix structure. It is permissible to give the entire street address in this structure and use the AddressFix structure for City, Postal Code and Country Sub-Entity in situations where the filer's database does not specify the street address as expected by the AddressFix structure. If

the address is reported by using both the AddressFix and the AddressFree structures, both structures are reported in one Address structure, not in two separate structures.

Element	Attribute	Size	Input Type	Requirement	Validated
AddressFree		1-4000 characters	taxfi:StringMin1Max4000_Type	Optional*	

- This is a free-text field for entering an address.
- Recommended format is street, city, postal code
- This structure is secondary in relation to AddressFix
 - If your AddressFix structure contains all the necessary addresses, you should leave out AddressFree
- However, this is a mandatory element if no address has been given in the AddressFix structure
- The address is mandatory and it must always be reported if the Financial Institution has the address information
 - If the Financial Institution does not have any current address or previously valid address on file, it can be reported as "Not known" in the AddressFree element.
 - o This means that the Financial Institution has declared and affirmed that it does not know the address, and that applicable law does not require that it should know the address.
- In case an individual Account Holder or a Controlling Person of a Passive Non-Financial Entity has been recorded a non-disclosure for personal safety reasons in the Population Information System, and the reporting financial institution has no information of a public contact address or other safe address for the customer, the AddressFree element should include the following text: "Non-disclosure for personal safety reasons based on domestic legislation".

6.4.3 DocSpec structures

The DocSpec contains information on the type of the report being filed (DocTypeIndic), ID information (DocRefId) and the IDs of the filing (CorrMessageRefId) and the reports (CorrDocRefId) to be corrected.

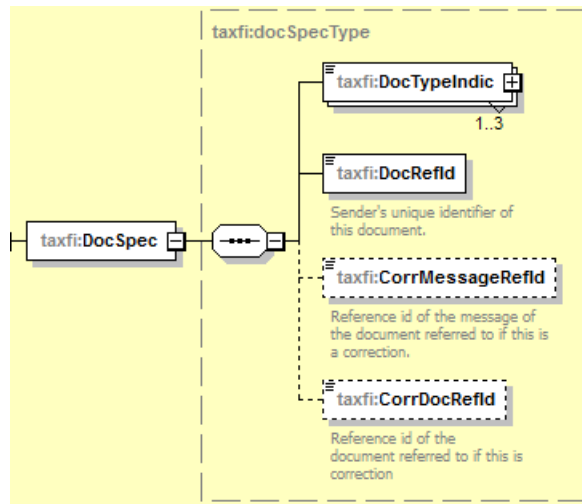

Element	Attribute	Size	Input Type	Requirement	Validated
DocTypeIndic		Listed values	taxfi:docTypeIndic_EnumType	Mandatory	Yes

- This element specifies the type of data being submitted.
- Allowable entries are:
 - o OECD0 = Resend CRS or DAC2 Data
 - o OECD1 = New CRS or DAC2 Data
 - o OECD2 = Corrected CRS or DAC2 Data
 - o OECD3 = Deletion of CRS or DAC2 Data

Element	Attribute	Size	Input Type	Requirement	Validated
DocRefId		1-200 characters	taxfi:StringMin1Max200_Type	Mandatory	Yes

- The ID code for the filing
- Reporting Financial Institutions must make sure they do not use the same DocRefId on annual information returns and on previously submitted CRS/DAC2 returns and FATCA returns.
- It is recommended that a DocRefId is compiled of the following parts
 - o Filer's GIIN is issued. Example: G1TFL0.00039.SL.246
 - o A period (.)
 - o Finnish Business ID
 - o A hyphen (-)
 - o A unique string consisting e.g. of the tax year and an ordinal number: 2018-001-002
 - o maximum length is 200 characters
- An example of a DocRefId in its entirety: G1TFL0.00039.SL.246.6606611-7-2018-001-002

Element	Attribute	Size	Input Type	Requirement	Validated
CorrMessageRefId		1-170 characters	taxfi:StringMin1Max170_Type	Optional	

- Use this when making a correction and DocTypeIndic is OECD2 or OECD3
- For more information on the MessageRefId of the return being corrected, see 6.1 MessageSpec.
- This can only be used when correcting a previously filed return.
- Ilmoitin makes a check on this entry when DocTypeIndic = OECD2 or OECD3

Element	Attribute	Size	Input Type	Requirement	Validated
CorrDocRefId		1-200 characters	taxfi:StringMin1Max200_Type	Optional	

- Use this when making a correction and DocTypeIndic is OECD2 or OECD3
- The DocRefId of the return being corrected.
- This can only be used when correcting a previously filed return.
- Ilmoitin makes a check on this entry when DocTypeIndic = OECD2 or OECD3.

7 CHECKS MADE BY ILMOITIN.FI

These checks prevent the return from being sent if an error or omission is detected in the data.

The check was added (if added after 1 Jan 2019, the month and the year are shown)	Data element	Description
3/2024	All records	The file is not identified as a CRS/DAC2 report. Check that XML complies with the schema. #File [] does not contain acceptable data. The check routine cannot be run. Attachments to income tax returns are submitted through the Attachment files page.
	All records	The submitted filing contains unacceptable characters, or unacceptable combinations of characters (-, &#, ' or /*) #Aineisto pitää sisällään kiellettyjä merkkejä tai merkkijhdistelmiä (-, &#, ' tai /*)
6/2020	Encoding	The required encoding for XML files is UTF-8. This must be indicated at the start of the XML file: <?xml version="1.0" encoding="UTF-8"?>
		The deadline date for the annual information return is checked #Ilmoituksia ei oteta enää vastaan vuodelta []
	MessageTypelIndic	The first possible date of submittal for a Correction (MessageTypelIndic= "CRS702") is 1 September yyyy #CRS702 muotoista dataa otetaan vastaan ilmoituksen vuodelta 31.8.vvvv jälkeen
6/2020	Timestamp	A check is made to make sure that the value of the MessageSpec/Timestamp element is the current year. #Timestamp elementin vuosi tulee olla sama kuin kuluva vuosi.
	AccountReport	If the return is a "nil" return, Ilmoitin.fi will run a check to make sure no AccountReport structures are included #Nollailmoituksella ei saa antaa AccountReport -tietoja
	AccountReport	If the return is not a "nil" return (CRS701), Ilmoitin.fi checks that at least one AccountReport structure must be included #Jos kyseessä ei ole nollailmoitus, on ilmoitettava vähintään yksi AccountReport-rakenne
	SendingCompanyIN MessageRefId	Ilmoitin.fi checks the format of the Business ID #Virheellinen ytunnus [] elementissä []
	MessageRefId CorrMessageRefId	Ilmoitin.fi runs a check on the format of the Business ID – year – sequential running number

		#Elementti [] ei ole oikean muotoinen
	MessageRefId	The Business ID found in MessageRefId must be the same as that in the SendingCompanyIN element. #Elementin 'MessageRefId' y-tunnus ei vastaa elementin 'SendingCompanyIN' y-tunnusta
6/2019	SendingCompanyIN MessageRefId	Do not enter any identity codes found in the example files in your real reports #Esimerkkisanomilla olevaa y-tunnusta [] ei saa käyttää varsinaisilla sanomilla.
	CorrMessageRefId	Element 'MessageSpec/CorrMessageRefId' is mandatory if MessageTypeIndic is 'CRS702' #Elementti 'MessageSpec/CorrMessageRefId' on ilmoitettava kun raportin tyyppi on 'CRS702'
	CorrMessageRefId	This is a mandatory data element when DocTypeIndic = OECD2 or OECD3. #Elementti 'ReportingFI/DocSpec/CorrMessageRefId' on ilmoitettava kun raportin tyyppi on 'OECD2' tai 'OECD3'
	CorrMessageRefId	MessageTypeIndic 'CRS702' can only be used in a correction message. #Elementti 'MessageSpec/CorrMessageRefId' ei ole sallittu kun raportin tyyppi on 'CRS701'
	DocRefId	Same DocRefId can't be used multiple times. Check is made for new messages and replacing messages (MessageTypeIndic = 'CRS701' or 'CRS703') whose previously sent MessageRefId is found from ilmoitin.fi #Olet lähettämässä ilmoitusta jo aiemmin käytetyllä DocRefId:llä: [DocRefId]
	CorrDocRefId	CorrDocRefId is mandatory if DocTypeIndic = OECD2 or OECD3. #Elementti 'DocSpec/CorrDocRefId' on ilmoitettava kun raportin tyyppi on 'OECD2' tai 'OECD3'
6/2021	ReportingFI/DocSpec/DocTypeIndic ReportingFI/DocSpec/DocRefId	When ReportingFI's DocTypeIndic value is OECD0, the reported DocRefId must be the same that has been reported earlier. #DocRefId tunnusta ei löydy aikaisemmin annetulta ilmoitukselta (ReportingFI OECD0)
6/2021	.../DocSpec/DocTypeIndic .../DocSpec/CorrDocRefId	When DocTypeIndic is OECD2 or OECD3 the reported CorrDocRefId must be found from a previous report. #Annettua CorrDocRefId:tä ei löydy aiemmin lähetetyistä aineistoista
	DocTypeIndic	Correction reports cannot contain new data (DocTypeIndic=OECD1) along with corrections (OECD2) and deleted data (OECD3) #Jos 'MessageTypeIndic' on CRS701 ei sanomalla saa olla tietoja joiden 'DocTypeIndic' on OECD2 eikä OECD3. Vastaavasti jos

		'MessageTypeIndic' on CRS702 ei sanomalla saa olla tietoja joiden 'DocTypeIndic' on OECD1.
	DocTypeIndic MessageTypeIndic	The value of DocTypeIndic "OECD1" can only be used on an original report or on a replacement (MessageTypeIndic = "CRS701"). #Jos 'MessageTypeIndic' on CRS701 ei sanomalla saa olla tietoja joiden 'DocTypeIndic' on OECD2 eikä OECD3. Vastaavasti jos 'MessageTypeIndic' on CRS702 ei sanomalla saa olla tietoja joiden 'DocTypeIndic' on OECD1.
	DocTypeIndic MessageTypeIndic	The values of DocTypeIndic "OECD2" and "OECD3" can only be used on a replacement (MessageTypeIndic = "CRS702"). #Jos 'MessageTypeIndic' on CRS701 ei sanomalla saa olla tietoja joiden 'DocTypeIndic' on OECD2 eikä OECD3. Vastaavasti jos 'MessageTypeIndic' on CRS702 ei sanomalla saa olla tietoja joiden 'DocTypeIndic' on OECD1.
6/2020	AccountReport/Accountnumber	AccountNumber cannot be blank #Jos ../AccountReport/Accountnumber-elementti löytyy ilmoitukselta, se ei saa olla tyhjä
	AccountNumberType AccountNumber	Enter the correct format of the bank account number for IBAN accounts (AccountNumberType=OECD601) or ISIN accounts (AccountNumberType=OECD603) No blankspace is allowed before an IBAN or ISIN account number and/or after it. #Virheellinen IBAN-/ISIN -numero '[' elementissä AccountNumber
	AccountHolder/Individual/Address SubstantialOwner/Individual/Address ReportingFi/Address	If the AddressFree structure is reported, it cannot be left blank #Jos ../AddressFree-elementti löytyy ilmoitukselta, se ei saa olla tyhjä
	AccountHolder/Individual/BirthInfo/BirthDate	Year of birth must be a value from "1900" to "current year" #Elementin 'Individual/BirthInfo/BirthDate' arvo ei ole sallituissa rajoissa (1900-01-01 - <kuluva vuosi>-12-31)
8/2019	AccountHolder/Organisation/IN/@IssuedBy	If the '000000000' dummy value is filled in for the IN, you must not enter an IssuedBy attribute #Jos "AccountHolder/Organisation/IN" on ilmoitettu keinoarvolla '000000000', attribuuttia 'AccountHolder/Organisation/IN/@IssuedBy' ei saa ilmoittaa.
08/2023	AccountHolder/Individual/TIN/@IssuedBy ControllingPerson/Individual/TIN/@IssuedBy	If the '000000000' dummy value is filled in for the TIN, you must not enter an IssuedBy attribute #Jos "Individual/TIN" on ilmoitettu keinoarvolla '000000000', attribuuttia 'Individual/TIN/@IssuedBy' ei saa ilmoittaa.
8/2019	AccountHolder/Organisation/IN/@IssuedBy	Mandatory information if the IN is other than the '000000000' dummy value. #Pakollinen attribuutti 'AccountHolder/Organisation/IN/@IssuedBy' puuttuu.

08/2023	AccountHolder/Individual/TIN/@IssuedBy ControllingPerson/Individual/TIN/@IssuedBy	Mandatory information if the TIN is other than the '000000000' dummy value. #Pakollinen attribuutti 'Individual/TIN/@IssuedBy' puuttuu.
Updated 6/2020	ReportingFI/ResCountryCode	The value of ReportingFI/ResCountryCode must be 'FI' in all circumstances. To leave it blank or to not include this element is not allowed. #ReportingFI/ResCountryCode elementin arvo ei ole 'FI' tai elementti puuttuu ilmoitukselta.
	ReportingFI/IN	If the InType value of the attribute is USGIIN, the correct format of the GIIN is checked #Virheellinen US GIIN '[' elementissä ReportingFI/IN
	ReportingFI/IN	If ReportingFI/IN InType attribute value is 'TIN' the IN value must be a Finnish Business ID #Virheellinen Y-tunnus '[' elementissä ReportingFI/IN
6/2020	ReportingFI/IN	ReportingFI/IN is a required data element #ReportingFI/IN elementti puuttuu. Ilmoita GIIN tunnus. Jos GIIN-tunnusta ei ole, on ilmoitettava suomalainen y-tunnus. Jos ei ole kumpaakaan, on otettava yhteys Verohallintoon. GIIN tunnusta käytettäessä INType attribuutin arvo tulee olla 'US GIIN'. Y-tunnusta käytettäessä INType attribuutin arvo tulee olla 'TIN'
6/2020	ReportingFI/IN the "issuedBy" attribute	The value of the ReportingFI/IN issuedBy attribute must be either 'FI' or 'US'. The value of ReportingFI/IN INType must be 'US GIIN' if the value of issuedBy is 'US'. The value of ReportingFI/IN INType must be 'TIN' if the value of issuedBy is 'FI'. #ReportingFI/IN issuedBy attribuutin arvo ei täsmää INType tiedon kanssa. INType arvo tulee olla 'US GIIN' jos issuedBy on 'US'. INType arvo tulee olla 'TIN' jos issuedBy on 'FI'
Updated 3/2021	../Address/AddressFix/City	If ../Address/AddressFix/ structure is given then ../AddressFix/City element is mandatory and the element cannot be blank or consist of blankspaces only # ../Address/AddressFix/City-elementti ei saa olla tyhjä tai sisältää pelkkiä välilyöntejä
Updated 6/2020	../Name/FirstName	The element cannot be blank or consist of blankspaces only (1-n) #Elementti ../Name/FirstName arvo ei voi olla tyhjä tai sisältää vain välilyöntejä
	AccountNumber/ UndocumentedAccount	If the UndocumentedAccount attribute is "true" in the AccountNumber element, the value can only be "FI" #Elementti 'AccountHolder/Individual/ResCountryCode'. Jos 'AccountReport/AccountNumber'-elementin attribuutti 'UndocumentedAccount' on 'true', arvo saa olla ainoastaan 'FI'

	ControllingPerson	When the organization's AccountHolderType is CRS101, there must at least be one Controlling Person. #Jos elementin 'AcctHolderType' arvo on 'CRS101' on tilinhaltijan raportoitava myös 'ControllingPerson' -tiedot
	ControllingPerson	When the AcctHolderType is CRS102 or CRS103, there may not be Controlling Persons. #Jos elementin 'AcctHolderType' arvo on 'CRS102' tai 'CRS103' ei tilinhaltija saa raportoida 'ControllingPerson' tietoja.
6/2020	AccountHolder/Individual	No "controlling person" is allowed if the Account Holder is a natural person. #Elementti ../AccountHolder/Individual ei voi sisältää ControllingPerson rakennetta
	AccountBalance	The value cannot be negative, and you must give two decimals #Elementin 'AccountReport/AccountBalance' arvo ei saa olla negatiivinen #Elementin 'AccountReport/AccountBalance' arvo on ilmoitettava kahdella desimaalilla
	AccountBalance	When the account is a closed account (AccountNumber/ClosedAccount="true" or ClosedAccount="1"), its balance must be equal to 0.00 (zero) #Jos attribuutin 'AccountNumber/@ClosedAccount' arvo on true, ei elementin 'AccountBalance' arvo voi olla yli 0.
	Payment	The value cannot be negative, and you must give two decimals #Elementin 'Payment/PaymentAmnt' arvo ei saa olla negatiivinen #Elementin 'AccountReport/Payment/PaymentAmnt' arvo on ilmoitettava kahdella desimaalilla

8 MESSAGES FROM ILMOITIN.FI

The messages below do not prevent the return from being sent. The messages call the filer's attention to specific issues that are worth checking before the filer sends the return.

The message was added (if added after 1 Jan 2019, the month and the	Data element	Description

year are shown)		
6/2019	SendingCompanyIN	<p>Ilmoitin displays the MESSAGE if the Business ID found in the SendingCompanyIN element has already been in the original report for the same year, and the value of ReportingFI TIN/IN is different from the previously filed report (GIIN/Business ID is different). (This message is activated for reports sent after 11 June 2019)</p> <p>#Y-tunnuksella on jo annettu vuodelle [vuosi] ilmoitus, jossa ReportingFI -osiossa eri tunnus</p>
	MessageRefId	<p>The message appears if a report submitted earlier has had the same MessageRefId</p> <p>#Olet lähettämässä ilmoitusta jo aiemmin käytetyllä MessageRefId:llä, nyt lähetetty sanoma pyyhkii yli kaikki aiemmat samalla MessageRefId:llä lähetetyt ilmoitukset</p>
6/2020	ReportingFI/IN The "InType" attribute	<p>If the value of the ReportingFI/IN InType attribute is 'TIN', then a message appears prompting the Filer to give the GIIN if the Filer has a GIIN.</p> <p>#Jos ilmoittajalla on GIIN tunnus niin ilmoita se y-tunnuksen sijasta. GIIN tunnusta käytettäessä ReportingFI/IN attribuutin INType arvona tulee käyttää US GIIN</p>
Updated 03/2023	ReportingFI/DocSpec/DocTypeIndic	<p>If the value of ReportingFI/DocSpec/DocTypeIndic is OECD2 or OECD3, the following message will appear in ilmoitin.fi:</p> <p>You are about to delete or amend the ReportingFI structure. DocTypeIndic of ReportingFI structure can have value OECD2 only if you have identified an error in the ReportingFI structure which you need to correct. The only situation where you can remove the ReportingFI (using OECD3) is that you want to remove the entire previously submitted return.</p> <p>If there is nothing to correct in the ReportingFI structure, you must indicate the previous return's DocRefId under ReportingFI/DocSpec/DocRefId, and enter OECD0 as the value of ReportingFI/DocSpec/DocTypeIndic. In that case, the ReportingFI/DocSpec structure should not contain CorrMessageRefId element or CorrDocRefId element.</p> <p>#Olet poistamassa tai korjaamassa ReportingFI-rakennetta. ReportingFI-rakenteen DocTypeIndic saa olla OECD2 vain, jos ReportingFI-rakenteessa on huomattu virhe, jota ollaan korjaamassa. ReportingFI-rakenteen saa poistaa (OECD3) ainoastaan jos tarkoitus on kokonaisuudessaan poistaa aikaisemmin annettu ilmoitus.</p> <p>#Jos ReportingFI-rakenteessa ei ole korjattavaa, ilmoita ReportingFI/DocSpec/DocRefId-kohdassa aikaisemmalla ilmoituksella käytetty ReportingFI:n DocRefId-tunnus ja ilmoita ReportingFI/DocSpec/DocTypeIndic arvona OECD0. Tällöin ReportingFI/DocSpec-rakenteessa ei ilmoiteta CorrMessageRefId- eikä CorrDocRefId-elementtejä.</p>

	AccountTreatment	If this element is not included or it has been left blank, the message appears #Elementti 'ReportingGroup/AccountReport/AccountTreatment' on ilmoitettava
	Self-Certification	If this element is not included or it has been left blank, the message appears #Elementti 'ReportingGroup/AccountReport/Self-Certification' on ilmoitettava
	AccountType	If this element is not included or it has been left blank, the message appears #Elementti 'ReportingGroup/AccountReport/AccountType' on ilmoitettava
	AccountHolder/ Individual/TIN	The TIN must be entered in the exact format for all EU countries' TINs (including the Finnish personal identity code). The "000000000" value is permissible as well #Virheellinen TIN '[' elementissä *Individual/TIN'
9/2020	AccountHolder/ Individual/TIN	If the account is new (AccountTreatment=CRS982) AND AccountHolder TIN is nine zeros '000000000'. TIN is mandatory information for a new account. #TIN on pakollinen tieto aina uuden tilin osalta. Arvo '000000000' ei ole sallittu elementissä 'Individual/TIN'
9/2020	AccountHolder/ Organisation/IN	If the account is new (AccountTreatment=CRS982) AND AccountHolder IN is nine zeros '000000000'. IN is mandatory information for a new account. #IN on pakollinen tieto aina uuden tilin osalta. Arvo '000000000' ei ole sallittu elementissä 'Organisation/IN'
9/2020	AccountHolder/ Individual/TIN	If the account is new (AccountTreatment=CRS982) AND AccountHolder TIN element value is question mark (?) or hyphen (-). TIN is mandatory information for a new account. #TIN on pakollinen tieto aina uuden tilin osalta. Arvo '?' ei ole sallittu elementissä 'Individual/TIN' #TIN on pakollinen tieto aina uuden tilin osalta. Arvo '-' ei ole sallittu elementissä 'Individual/TIN'
9/2020	AccountHolder/ Organisation/IN	If the account is new (AccountTreatment=CRS982) AND AccountHolder IN element value is question mark (?) or hyphen (-). IN is mandatory information for a new account. #IN on pakollinen tieto aina uuden tilin osalta. Arvo '?' ei ole sallittu elementissä 'Organisation/IN' #IN on pakollinen tieto aina uuden tilin osalta. Arvo '-' ei ole sallittu elementissä 'Organisation/IN'
	AccountHolder/Individual/ ResCountryCode	If the UndocumentedAccount attribute is "true" in the AccountNumber element, the value can only be "FI" #Jos 'AccountReport/AccountNumber' elementin attribuutti 'UndocumentedAccount' on 'true', arvo saa olla vain 'FI'.

	AccountHolder/Individual/ ResCountryCode	If the value is "FI", the message appears in ilmoitin.fi: "please re-check that the country of residence is correct". This is to make sure that users only enter "FI" in circumstances where it is appropriate as per instructions #Varmista verotuksen asuinvaltion oikeellisuus: [maakoodi]
Updated 9/2021	AccountHolder/Individual/ Name/FirstName	If the value of AccountHolder/Individual/Name/FirstName is 'NFN', the following message appears in Ilmoitin The only situation where the value can be 'NFN' is when the account holder has no first name, or when the Reporting Financial Institution does not know the first name. #Arvo 'NFN' on sallittu vain, jos tilinhaltijalla ei ole etunimeä tai finanssilaitos ei tiedä tilinhaltijan etunimeä.
Updated 9/2021	ControllingPerson/ Individual/Name/FirstName	If the value of ControllingPerson/Individual/Name/FirstName is 'NFN', the following message appears in Ilmoitin The only situation where the value can be 'NFN' is when the controlling person has no first name, or when the Reporting Financial Institution does not know the first name. #Arvo 'NFN' on sallittu vain, jos kontrolloivalla henkilöllä ei ole etunimeä tai finanssilaitos ei tiedä kontrolloivan henkilön etunimeä.

9 FURTHER INFORMATION AND LINKS

The annual information return for CRS and DAC2 must be filed as instructed in the technical requirements herein. See below for further guidance and useful links.

Common Reporting Standard (CRS) User Guide and Schema

<http://www.oecd.org/tax/automatic-exchange/common-reporting-standard/schema-and-user-guide/>

For information on the XML Schema validations and on XML files that fulfil the Tax Administration's requirements of mandatory input, go to [Example files in the XML format](#).